

8 ま み む め も

1. よみましょう



1) ま み む め も

2) む ま め も み

3) ま め み む め も ま も

4) も む め ま み ま む め み も

2. よみましょう



1) うま



2) うみ



3) みみ



4) むし

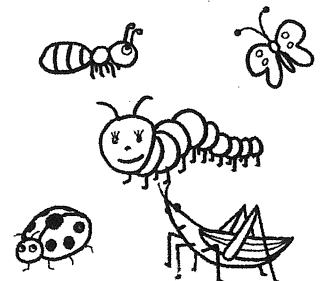

5) め

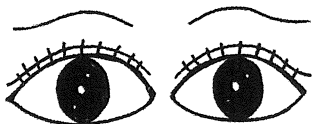

6) もも

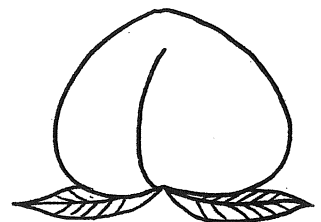

3. かきましょう



ま

ま(ま)みむめも

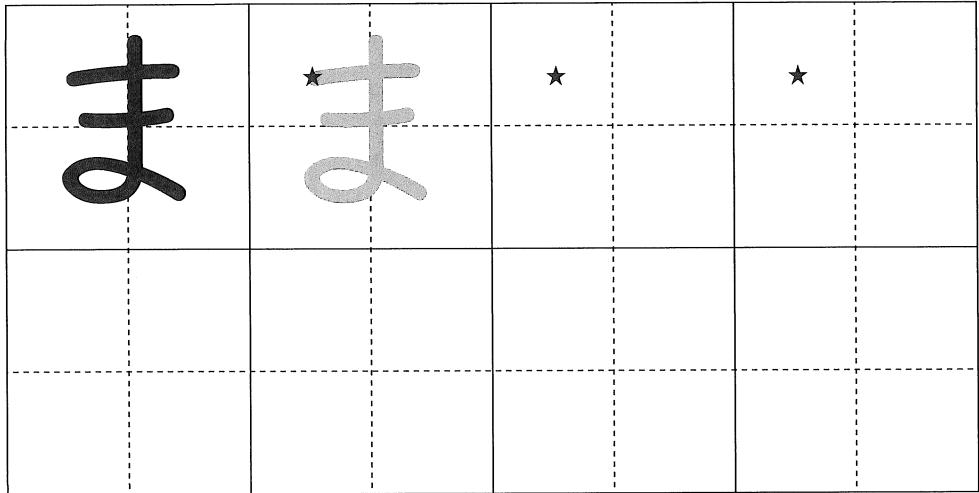
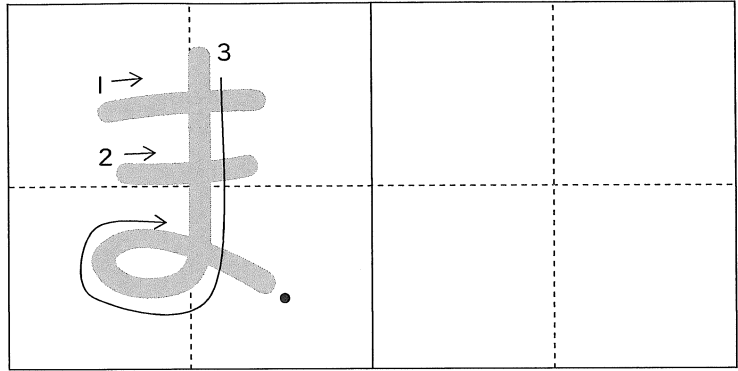

み

ま(み)むめも

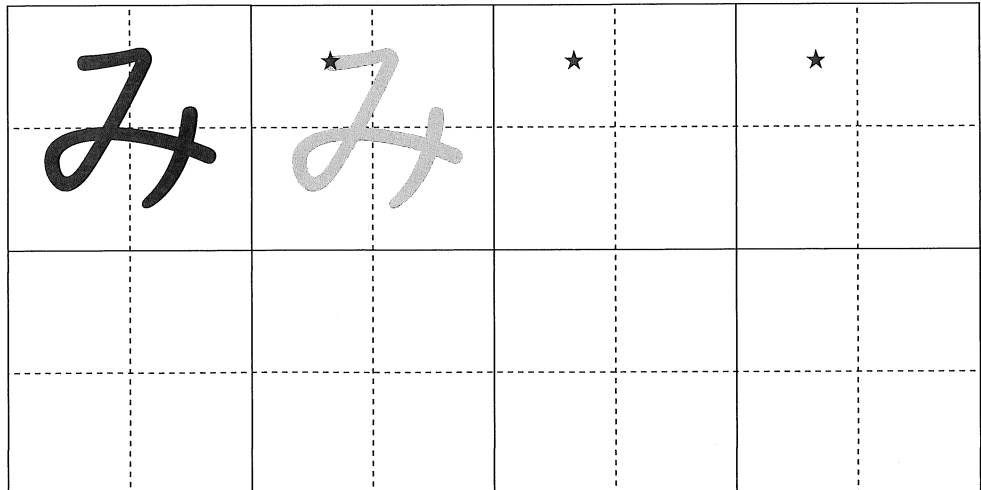
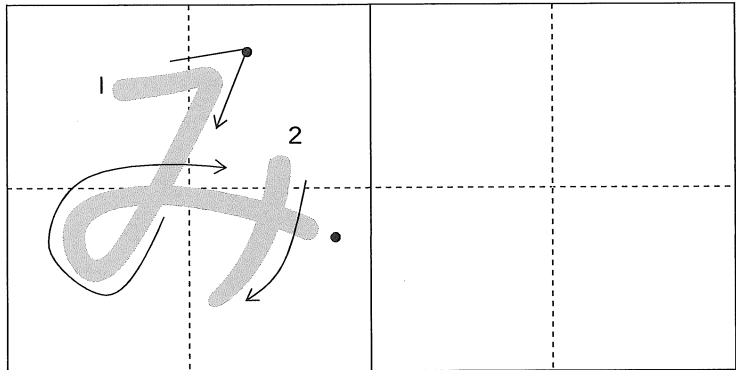

# む

まみむめも

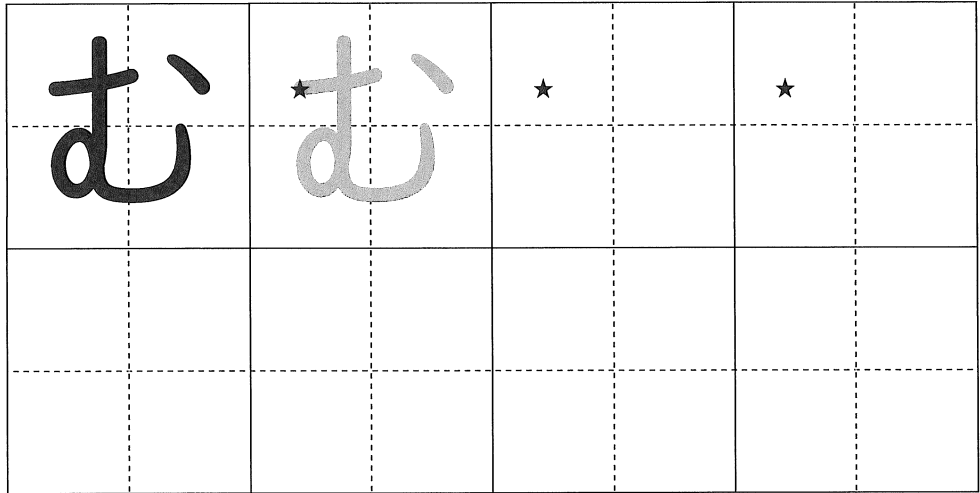
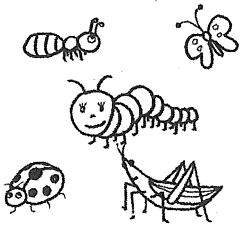
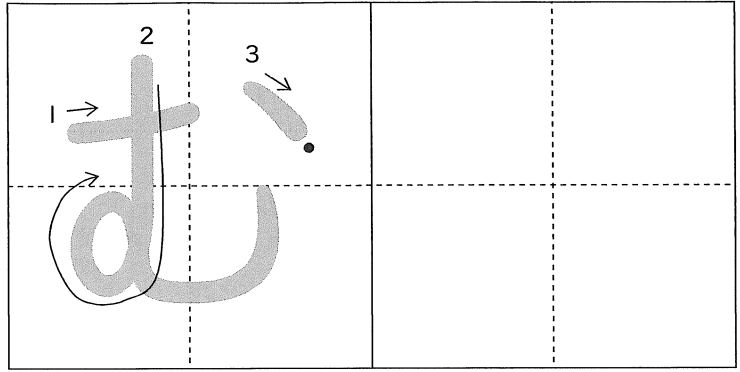

# め

まみむめも

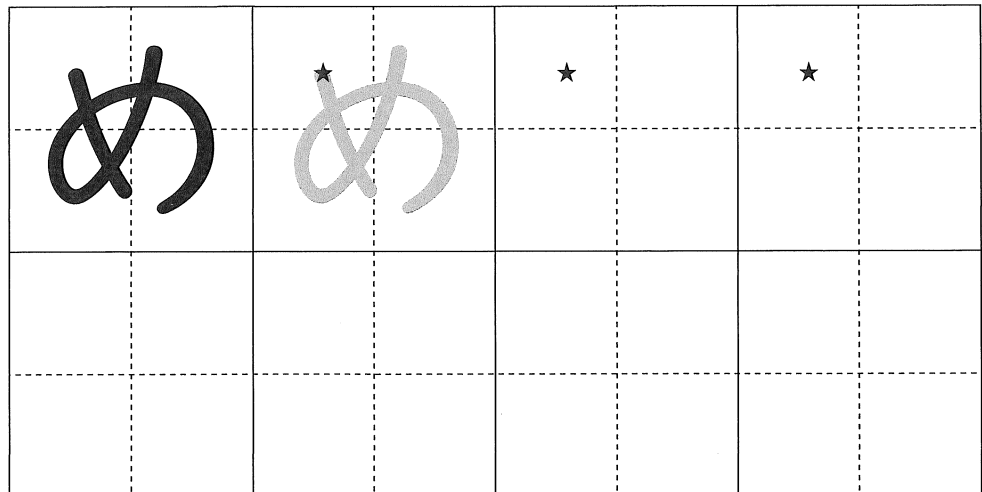
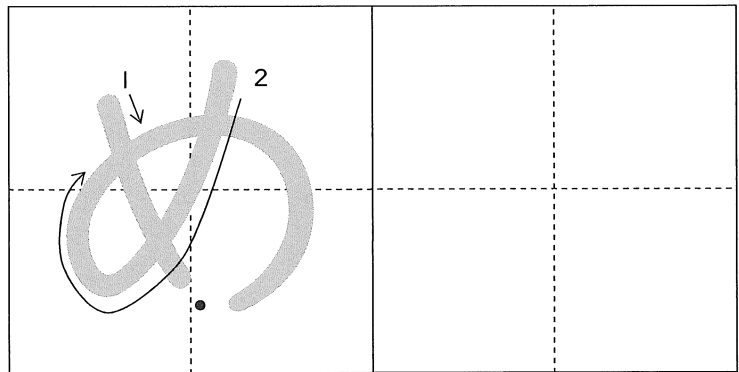

# も

ま み む め も

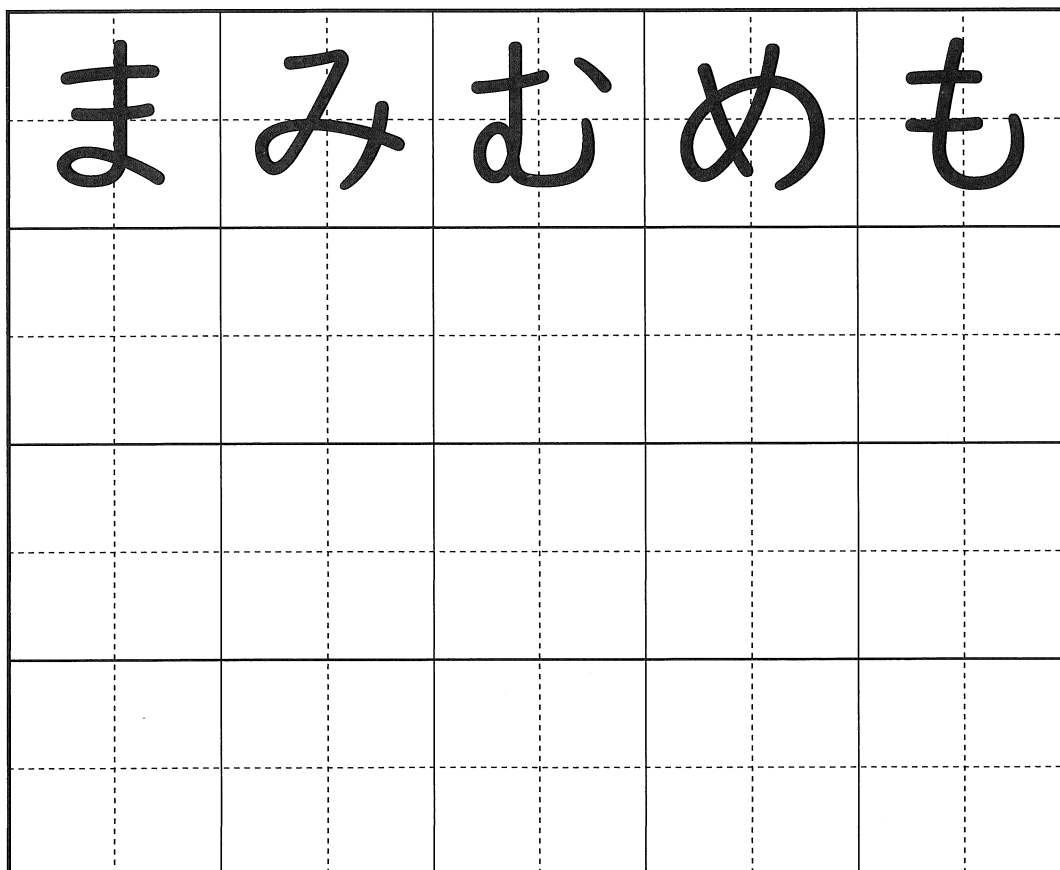
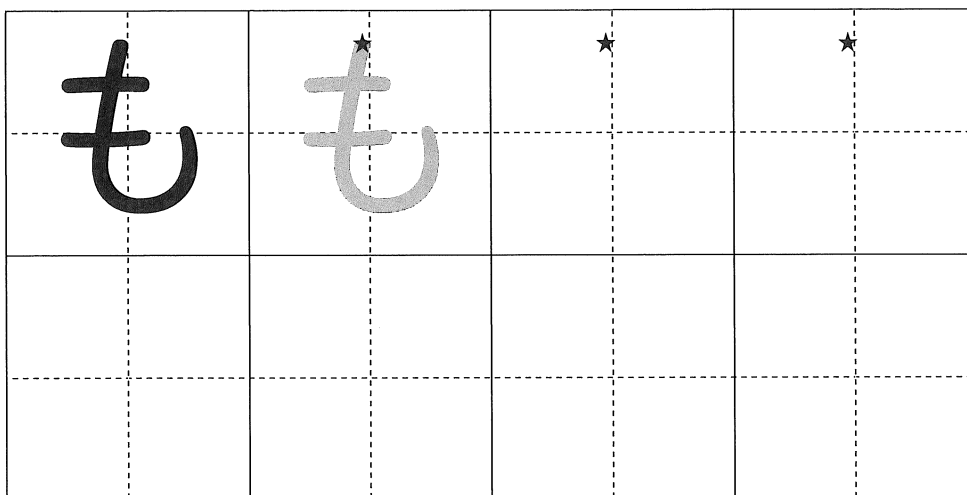
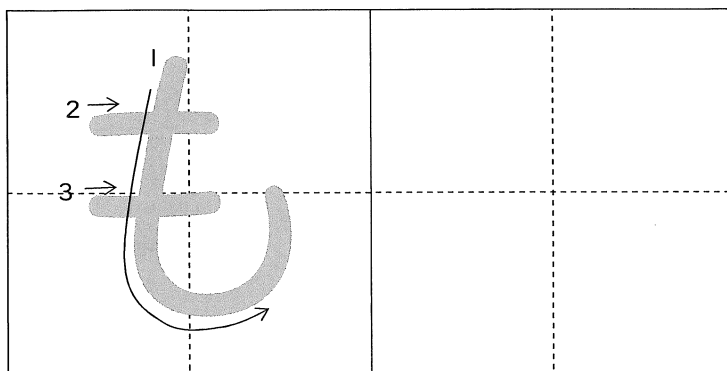

1)



うま

Blank handwriting practice box for the word 'uma'.

うま

Blank handwriting practice box for the word 'uma'.

2)



うみ

Blank handwriting practice box for the word 'umi'.

うみ

Blank handwriting practice box for the word 'umi'.

3)



みみ

Blank handwriting practice box for the word 'mimi'.

みみ

Blank handwriting practice box for the word 'mimi'.

4)

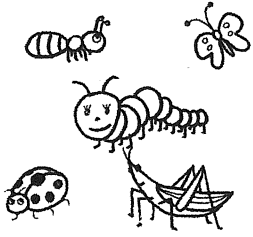

む し

Blank handwriting practice box with dashed lines.

む

し

Blank handwriting practice box with dashed lines.

Blank handwriting practice box with dashed lines.

5)



め

Blank handwriting practice box with dashed lines.

め

Blank handwriting practice box with dashed lines.

Blank handwriting practice box with dashed lines.

Blank handwriting practice box with dashed lines.

Blank handwriting practice box with dashed lines.

Blank handwriting practice box with dashed lines.

6)

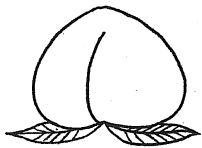

も も

Blank handwriting practice box with dashed lines.

も

も

Blank handwriting practice box with dashed lines.

Blank handwriting practice box with dashed lines.

4. どれですか

もも  
●

め  
●

むし  
●

みみ  
●

うま  
●

うみ  
●

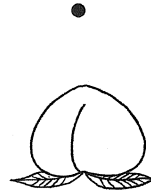
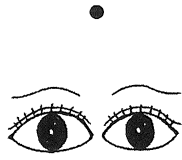

5. かきましょう



④  
み

③  
ま

②  
み

①  
し

も

う

う

み

む

も







も
も

6. ききましょう かきましょう

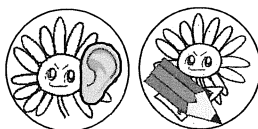

1)

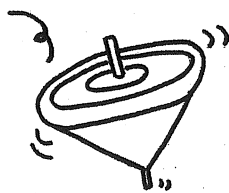

こ

2)

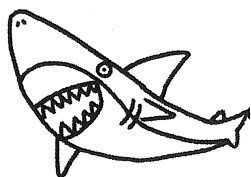

さ

3)



か

きり

4)

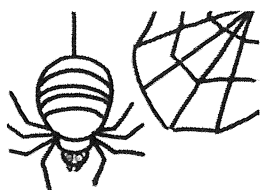

く

5)



あ

6)

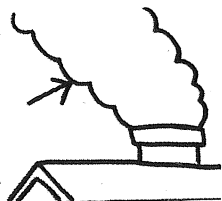

け

り

7)



か

8)

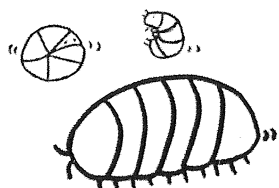

だんご

し



9 や ゆ よ

1. よみましょう 

1) や ゆ よ

2) ゆ や ゆ よ や よ

3) や ゆ よ や よ ゆ よ

4) よ ゆ や よ ゆ よ や よ

2. よみましょう 

1) やま



2) やさい



3) ゆき



4) ゆめ



5) よこはま



6) ひよこ

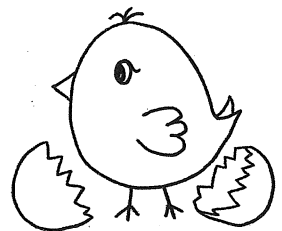

3. かきましよう



や

や ゆ よ

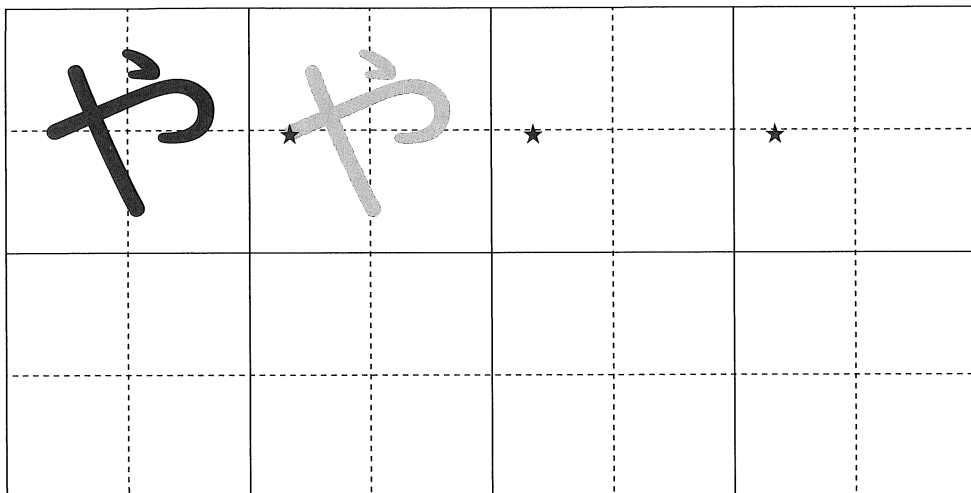
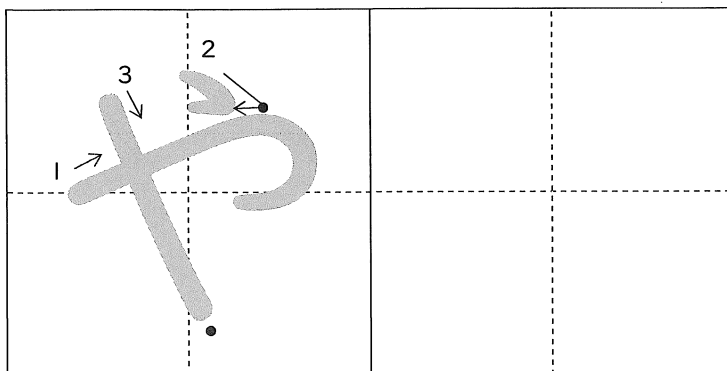

ゆ

や ゆ よ

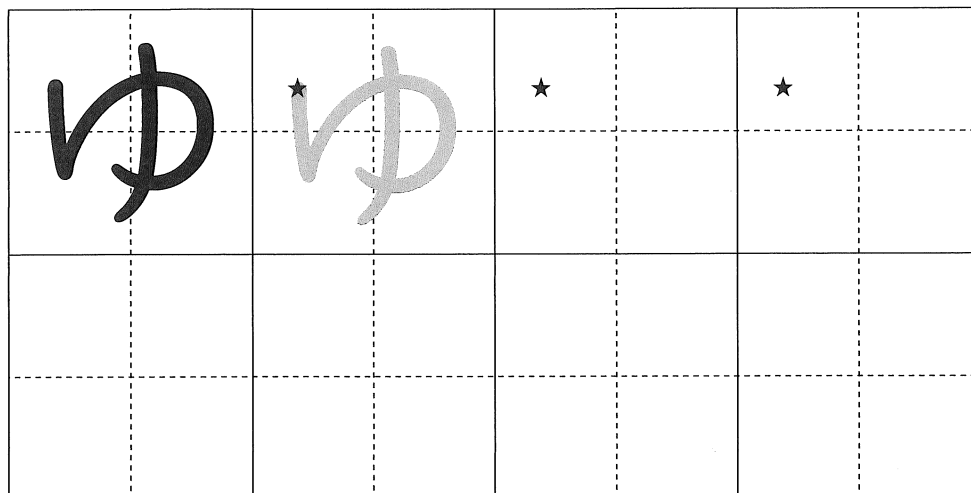
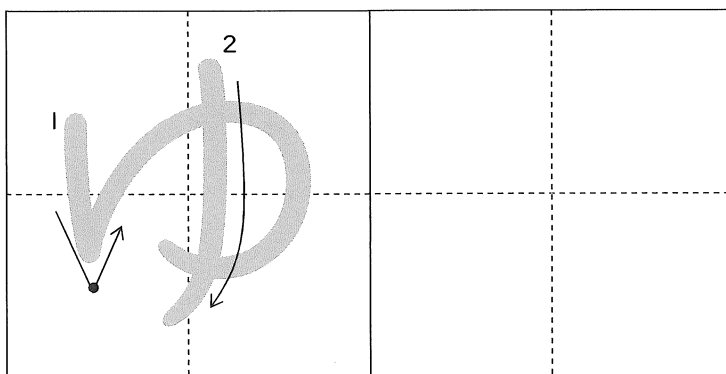

よ  
やゆよ

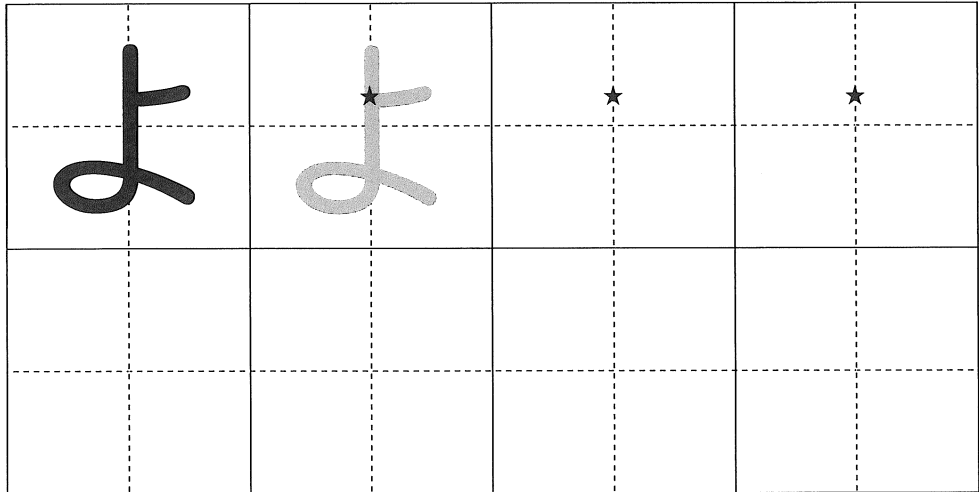
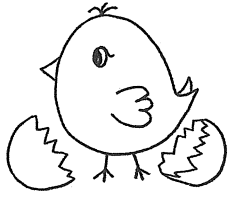
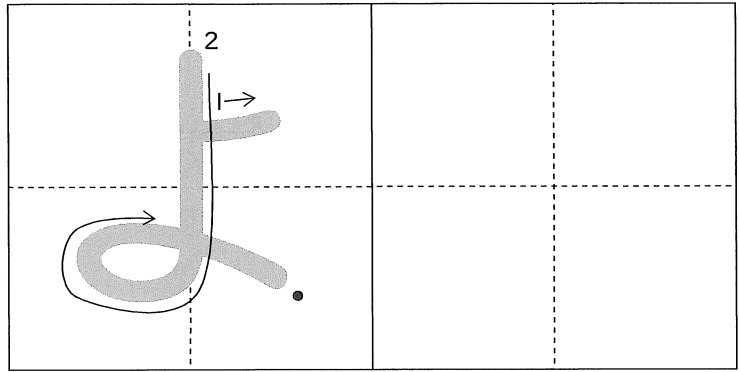

1)



やま

やま

2)



やさい

やさい

3)



ゆき

ゆき

4)



ゆ	め
---	---

ゆ
---

--

--	--

め
---

--

5)



よ	こ	は	ま
---	---	---	---

--	--	--	--

6)

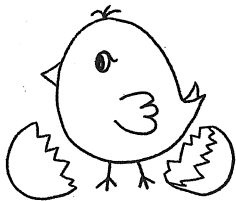

ひ	よ	こ
---	---	---

--	--	--

ひ
---

--

よ
---

--

こ
---

--

4. どれですか

やさい

ゆき

やま

ゆめ

ひよこ

よこはま

●

●

●

●

●

●



5. かきましよう

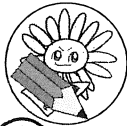

④ は

③ い

② こ

① め

き

こ

さ

ひ

ゆ

ゆ

よ

や

よ

ま















ゆ
き

6. ききましょう かきましょう

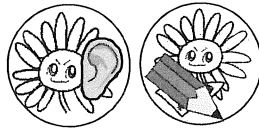

1)

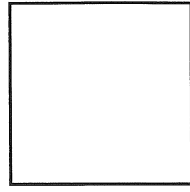
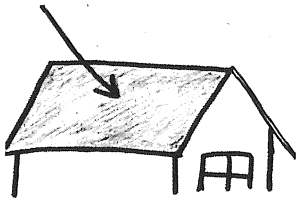

ね

2)

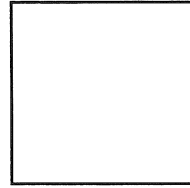
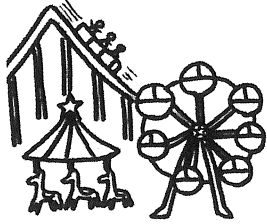

う えん ち

3)



ま

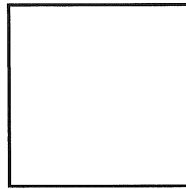

げ

4)



く れ

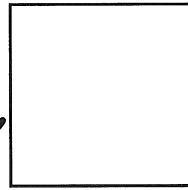

ん

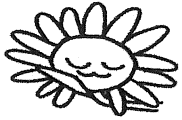

【ひとやすみ③】

なにが かくれて いるかな？

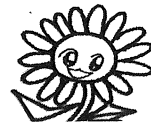

(れい)



(1)

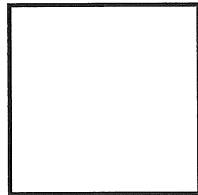
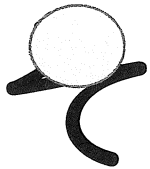

(2)

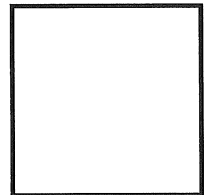
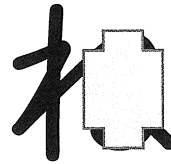

(3)

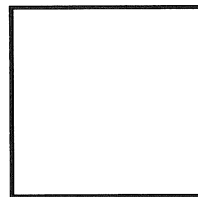
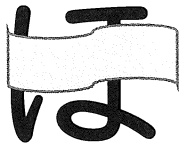

(4)

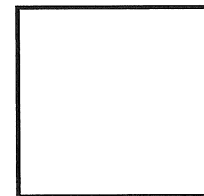

(5)

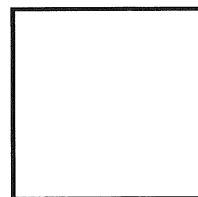

(6)

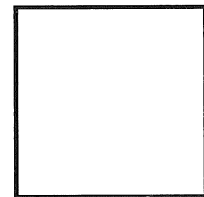

(7)

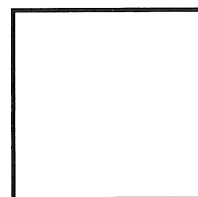

(8)

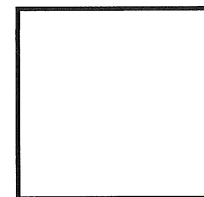



10 ら り る れ ろ

1. よみましよう 

1) ら り る れ ろ

2) る ら れ ろ り

3) ら れ り る れ ろ ら ろ

4) ろ る れ ら り ら る れ り ろ

2. よみましよう 

1) さくら



2) のり

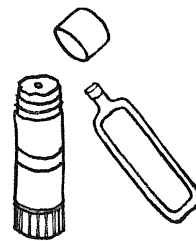

3) くるま



4) さる

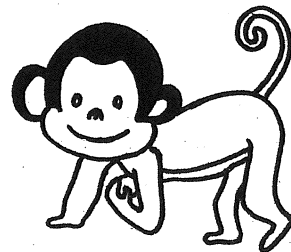

5) といれ

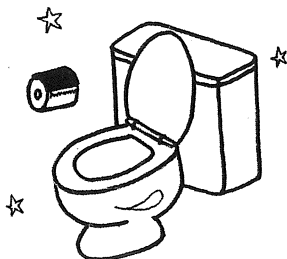

6) ろく



3. かきましよう



ら  
 らりるれろ

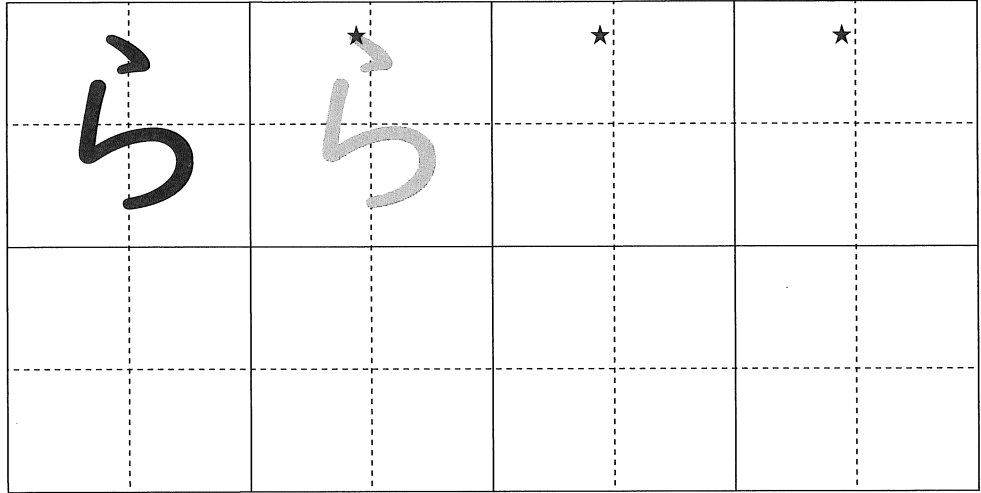
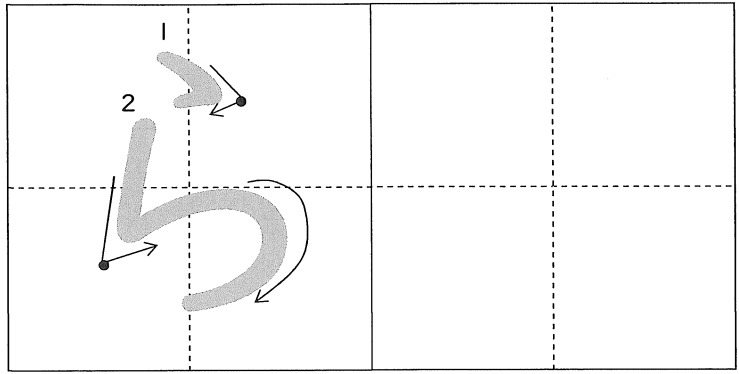

り  
 らりるれろ

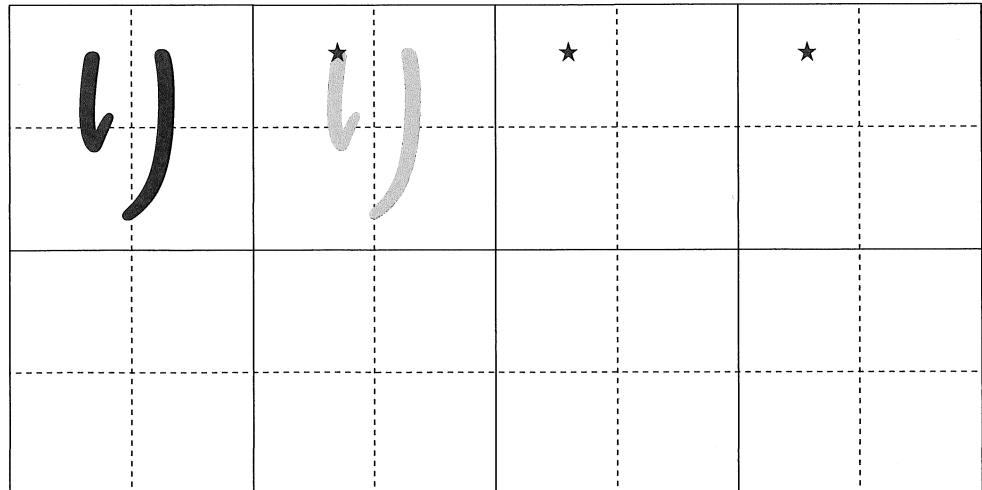
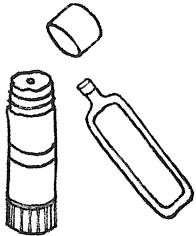
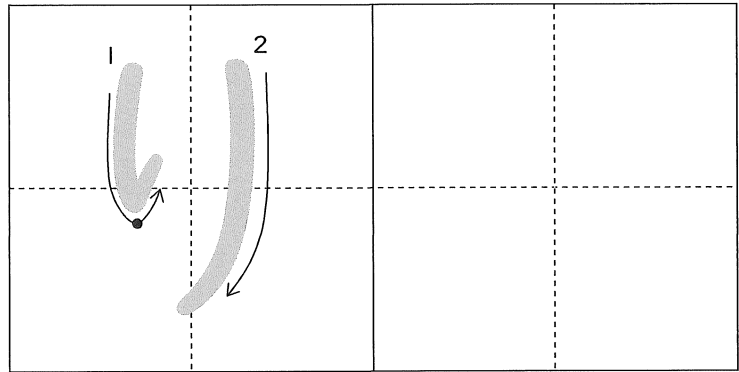

# る

らりる(る)れろ

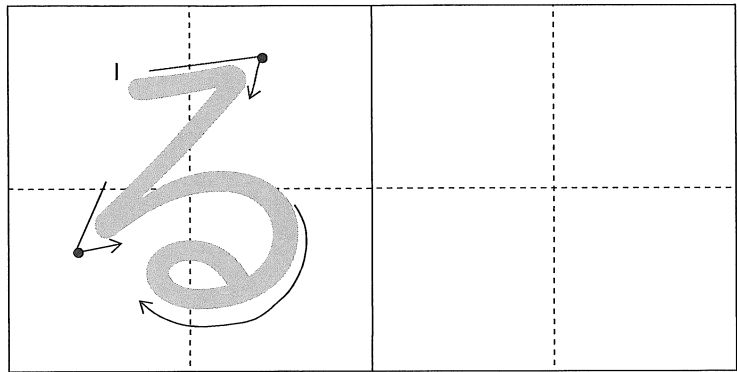

る	る	★	★

# れ

らりる(れ)ろ

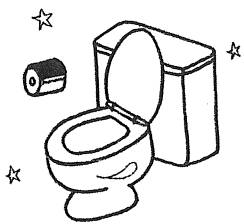
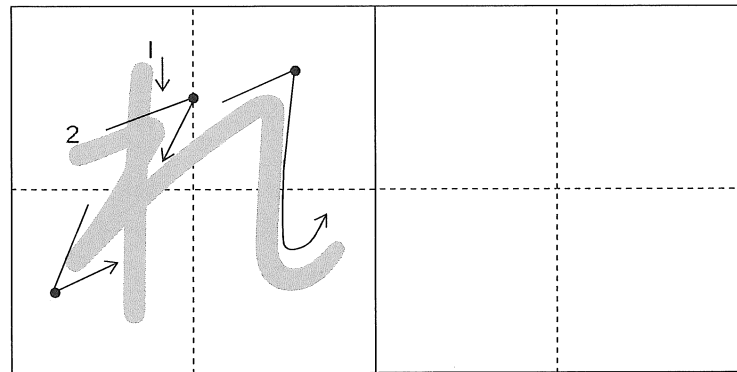

れ	れ	★	★

ろ

らりるれ③

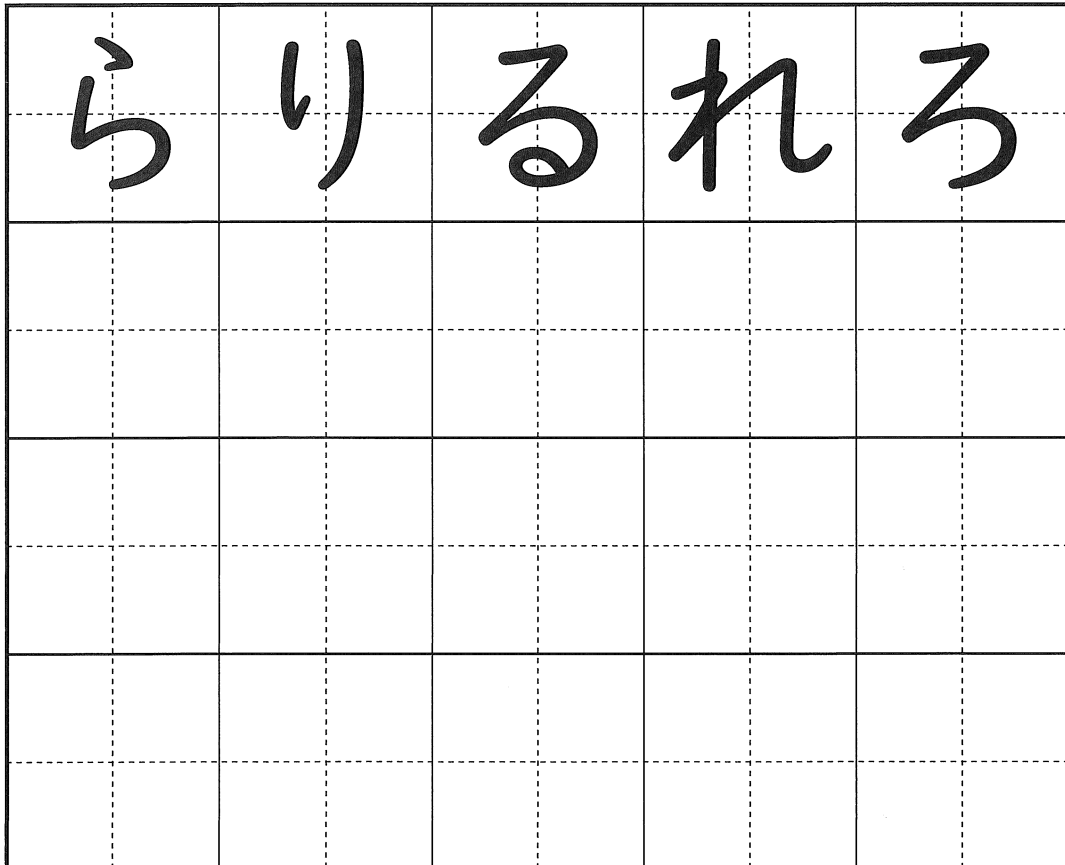
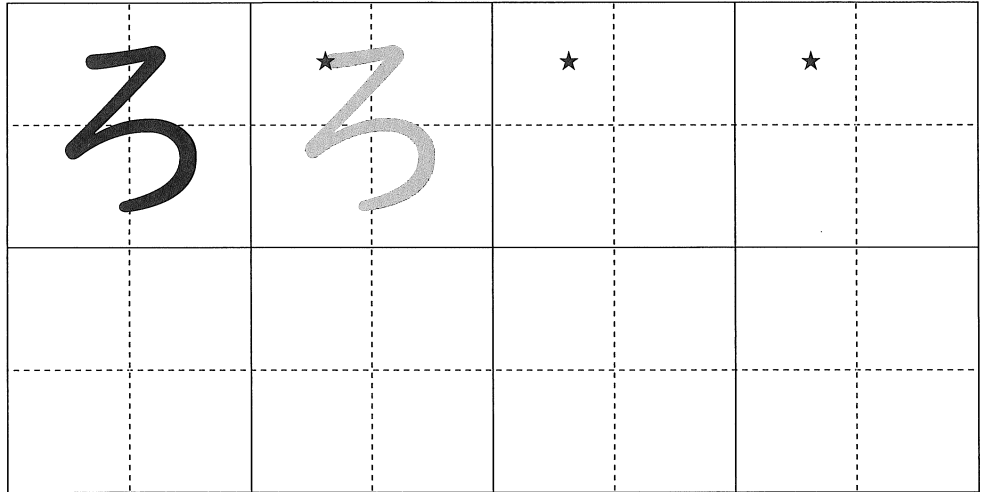
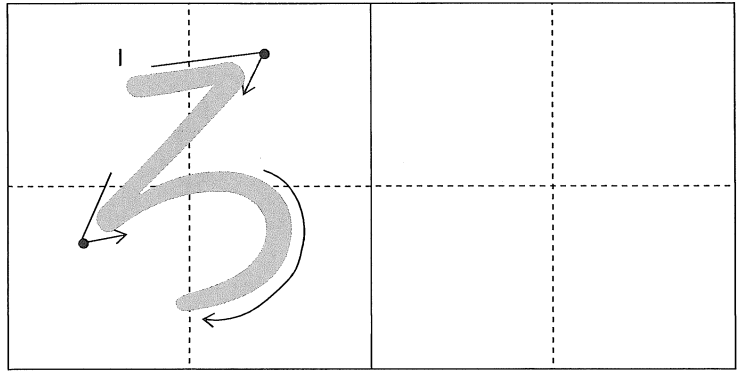

1)



さくら

Blank handwriting practice box for the word 'sakura'.

さくら

Blank handwriting practice box for the word 'sakura'.

2)

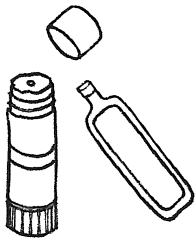

のり

Blank handwriting practice box for the word 'nori'.

のり

Blank handwriting practice box for the word 'nori'.

3)

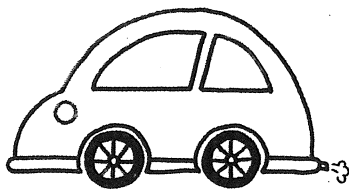

くるま

Blank handwriting practice box for the word 'kuruma'.

くるま

Blank handwriting practice box for the word 'kuruma'.

4)

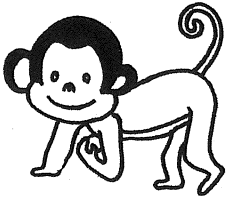

さる

Blank handwriting practice box with dashed lines.

さる

Blank handwriting practice box with dashed lines.

5)

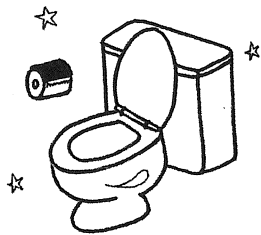

トイレ

Blank handwriting practice box with dashed lines.

トイレ

Blank handwriting practice box with dashed lines.

6)



ろく

Blank handwriting practice box with dashed lines.

ろく

Blank handwriting practice box with dashed lines.

4. どれですか

さる

のり

さくら

くるま

といれ

ろく

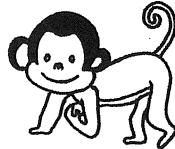
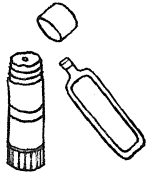

5. かきましよう

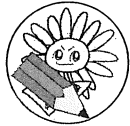

④  
さ

③  
い

②  
ま

①  
る

り

ら

れ

く

さ

の

く

と

る

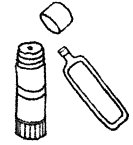





の
り

6. ききましょう かきましょう

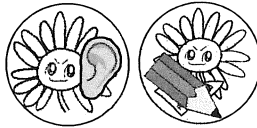

1)



と

2)

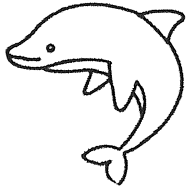

い

か

3)

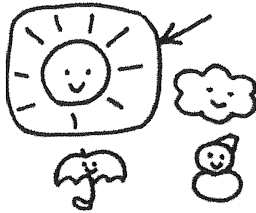

は

4)

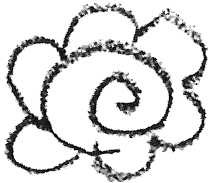

はなま

5)



いおん

6)

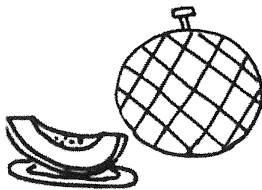

め

ん

7)



もん

8)

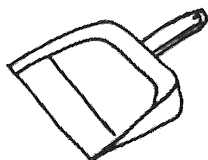

ち

と















【ひとやすみ④】

ひだりのひょうをみて、  
ひらがなをかいてね。

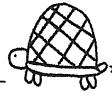



				
は	さ	い	や	し
				
う	つ	き	す	か



れい)



→

	
す	し



1)



2)

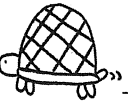

3)



4)

	

5)

6)



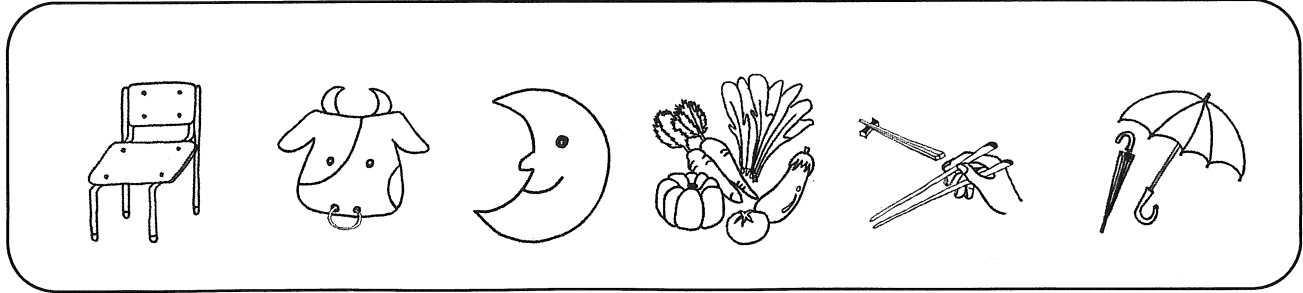

【ひとやすみ⑤】

# かくすう めいろ

指導される方へ: 3画で書くひらがなを通ります。

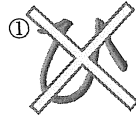

ね ほ あ  
た た に き  
お は す  
ぬ む ふ そ  
る み か ゆ  
け え ま

3. かきましよう



ん  
①

