

金沢八景駅東口地区土地区画整理事業

町名	地番		ページ
地区全体			2
金沢区瀬戸	5000	-1	3
	5000	-2	4
	5000	-3	5
	5000	-4	6
	5000	-5	7
	5000	-6	8
	5000	-7	9
	5000	-8	10
	5000	-9	11
	5000	-10	12
	5001	-1	13
	5001	-2	14
	5001	-3	15
	5001	-4	16
	5001	-5	17
	5001	-6	18
	5001	-7	19
	5001	-8	20
	5001	-9	21
	5001	-10	22
	5001	-11	23
	5001	-12	24
	5001	-13	25
	5001	-14	26
	5001	-15	27
	5001	-16	28
	5001	-17	29
	5001	-18	30
	5001	-19	31
	5002	-1	32
	5002	-2	33

町名	地番		ページ
金沢区瀬戸	5002	-3	34
	5002	-4	35
	5002	-5	36
	5002	-6	37
	5002	-7	38
	5002	-8	39
	5002	-9	40
	5002	-10	41
	5002	-11	42
	5002	-12	43
	5002	-13	44
	5002	-14	45
	5002	-15	46
	5002	-16	47
	5002	-17	48
	5003	-1	49
	5003	-2	50
	5003	-3	51
	5003	-4	52
	5003	-5	53
	5003	-6	54
	5003	-7	55
	5003	-8	56
	5003	-9	57
	5004	-1	58
	5004	-2	59
	5004	-3	60
	5004	-4	61
	5004	-5	62
	5004	-6	63
	5004	-7	64
	5004	-9	65

町名	地番		ページ
金沢区瀬戸	5004	-10	66
	5004	-11	67
	5004	-12	68
	5004	-13	69
	5005	-1	70
	5005	-2	71
	5005	-3	72
	5005	-4	73
	5005	-5	74
	5005	-6	75
	5005	-7	76
	5005	-8	77
	5005	-9	78
	5005	-10	79
	5006		80
	5007		81
	5008		82
	5009		83
	5010		84
	5011		85
5012		86	
5013		87	
5014		88	
5015		89	
5016		90	
5017		91	
5018		92	
5019		93	
5020		94, 95	



△ S2-07

地区外

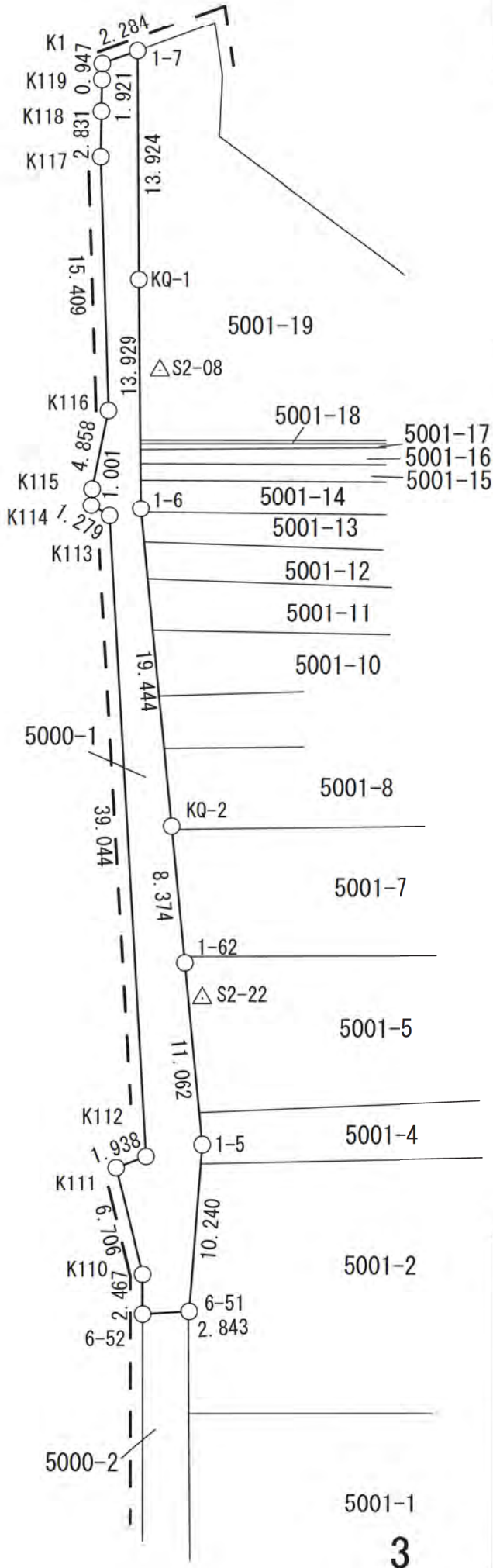

基準点網図

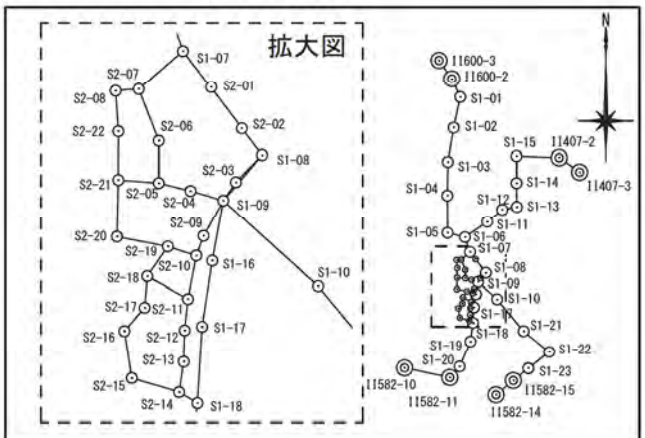



地区外

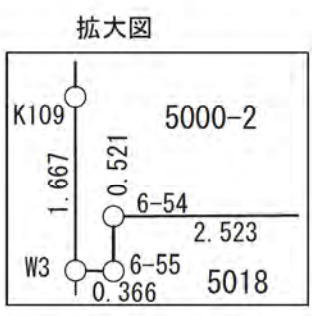
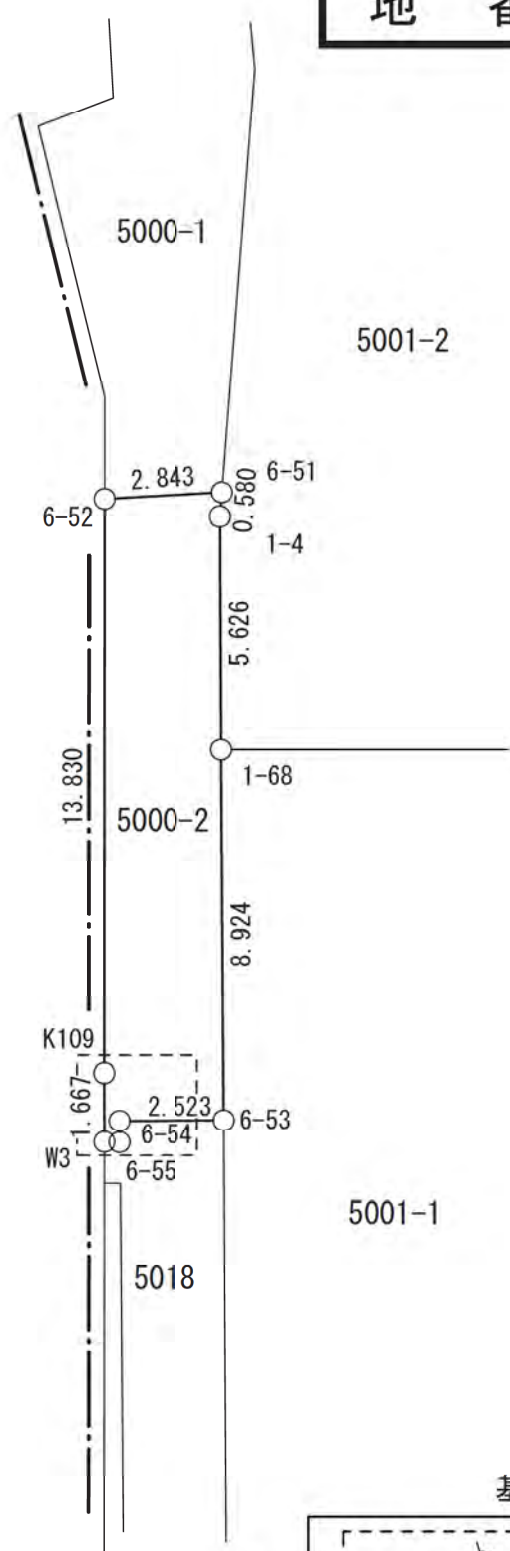

基準点網図

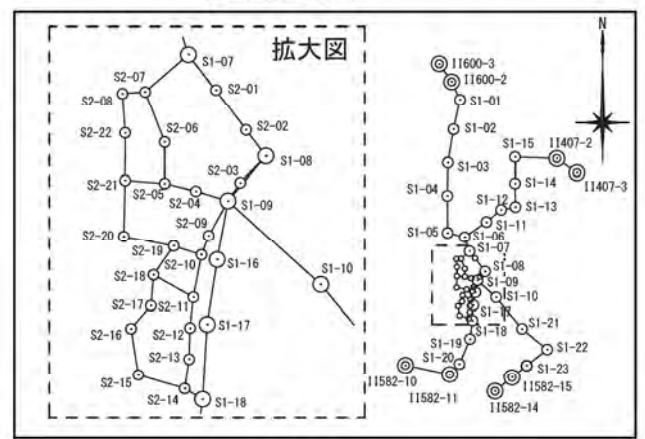

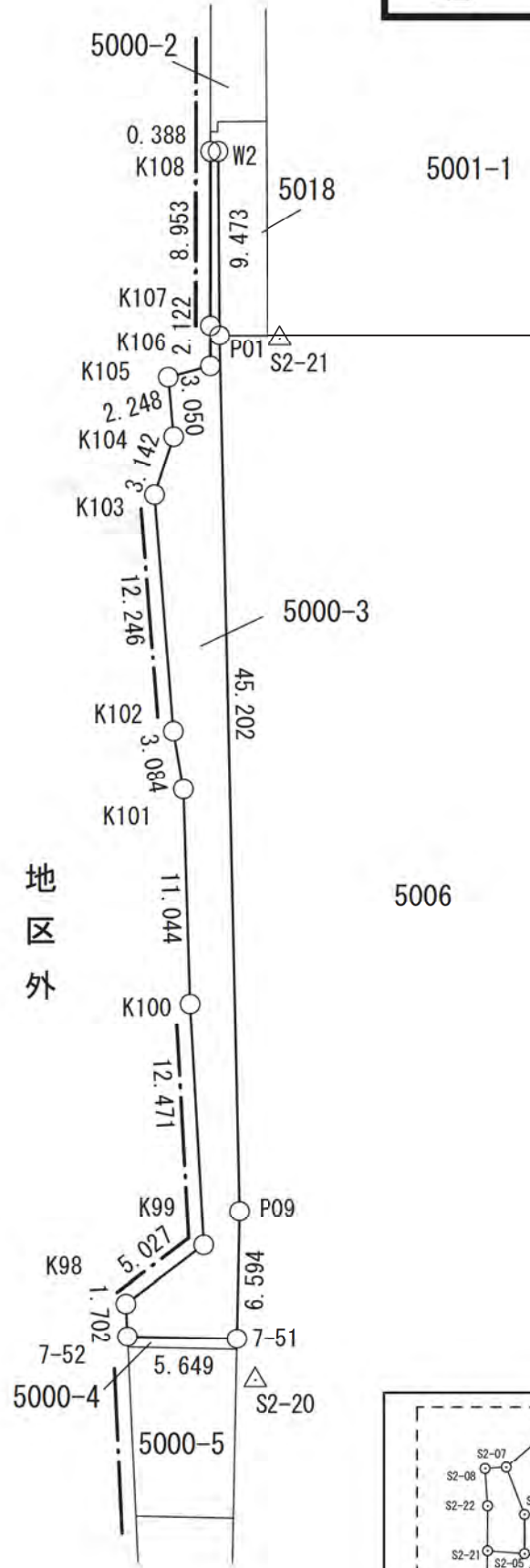

基準点網図

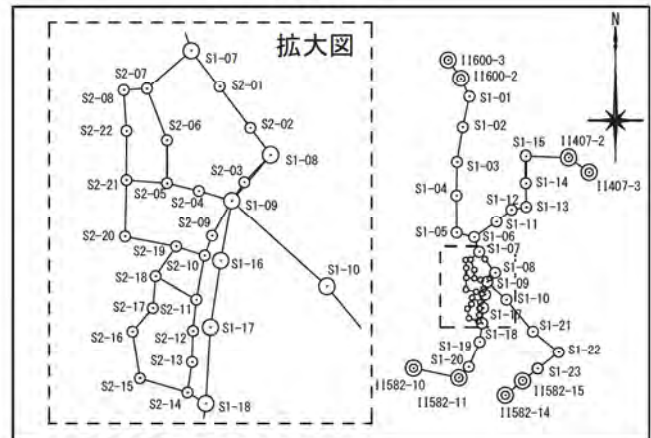



地 番	5000-4
-----	--------

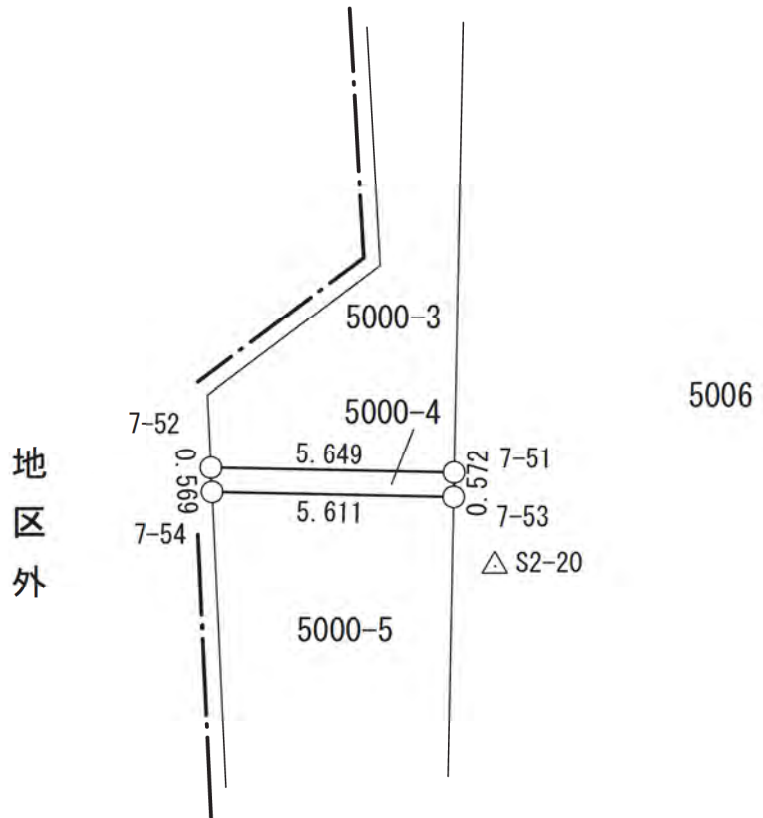

地区外

基準点網図

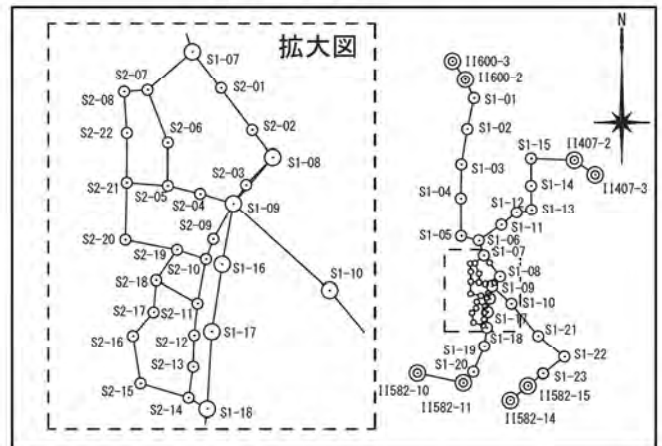



地区外

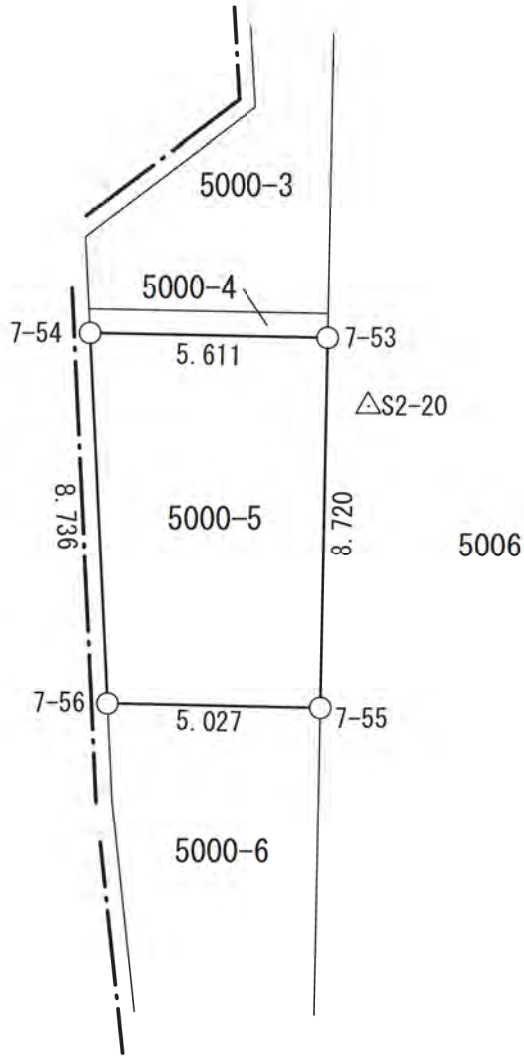

基準点網図

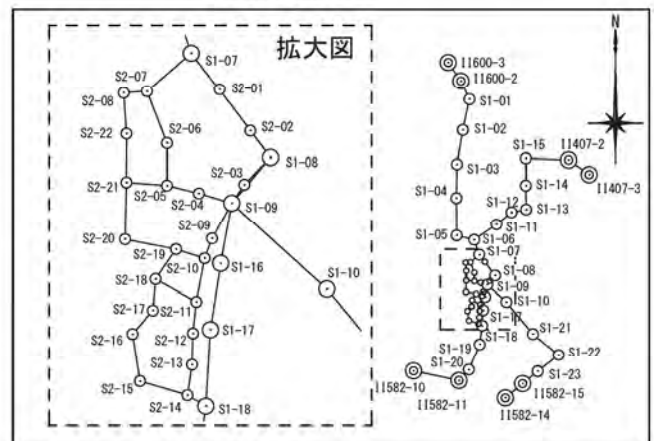



地区外

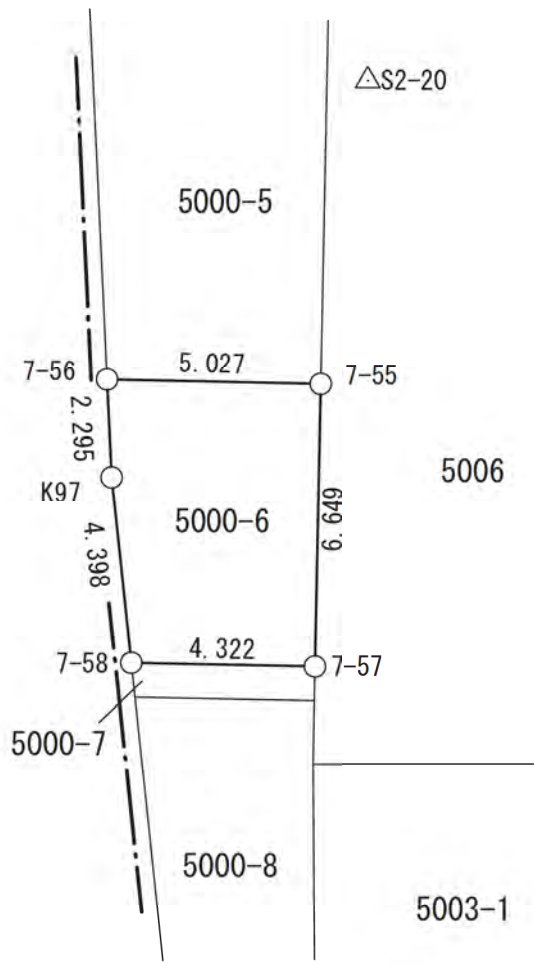

基準点網図

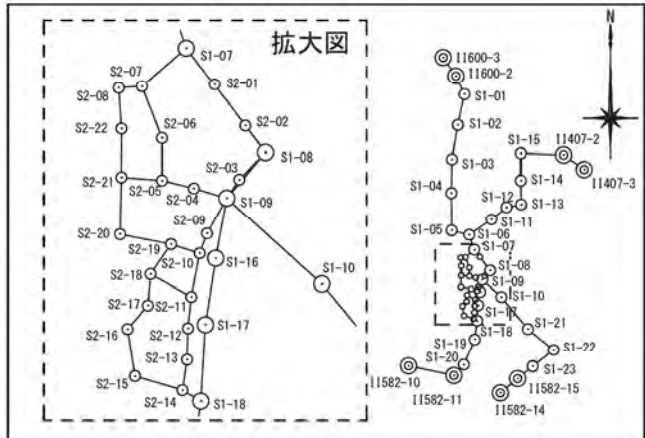



△S2-20

地区外

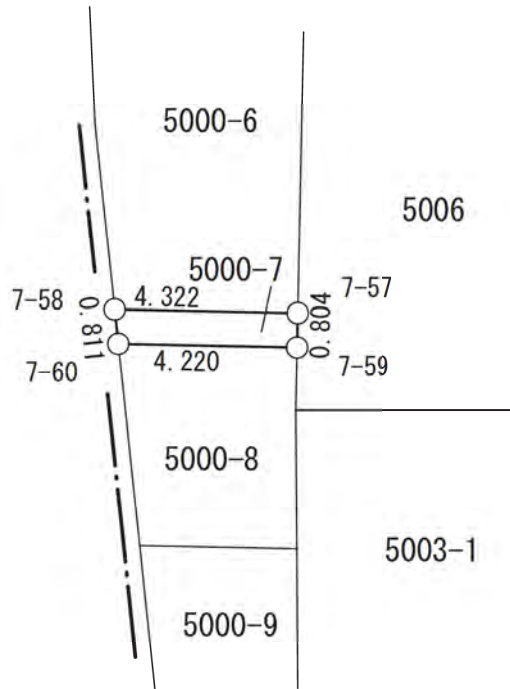

基準点網図

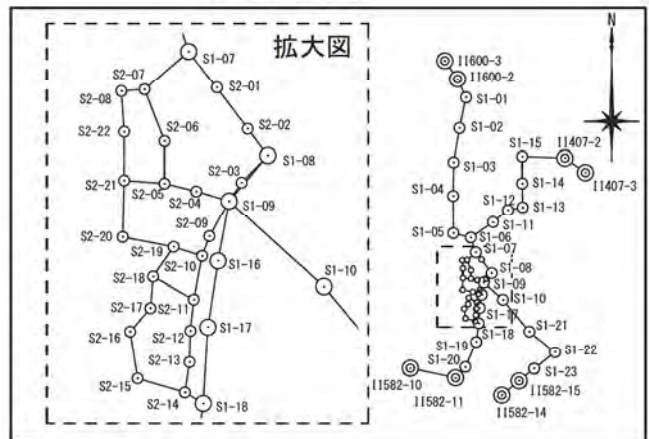



△S2-20

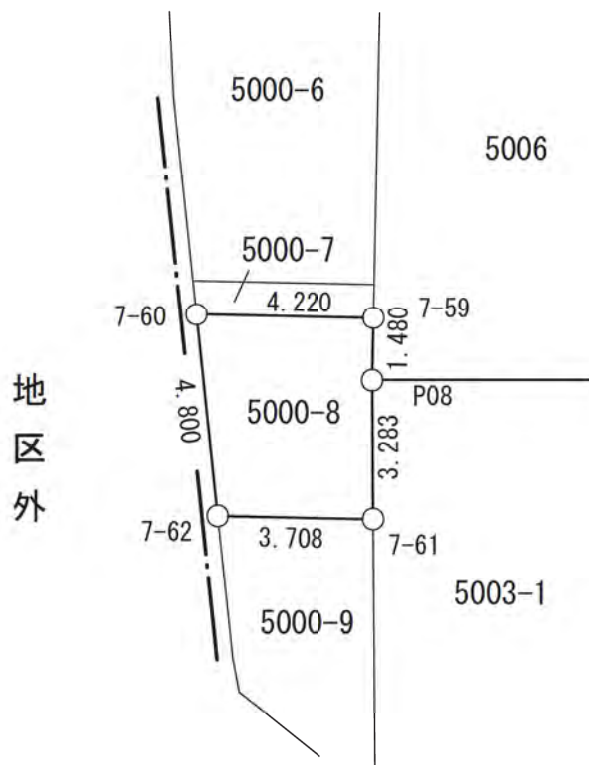

基準点網図

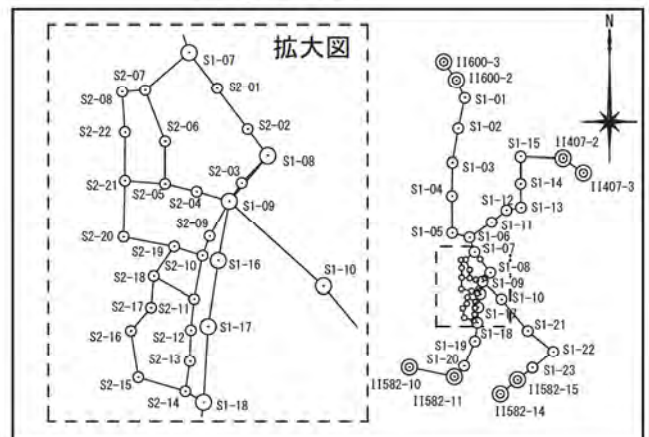

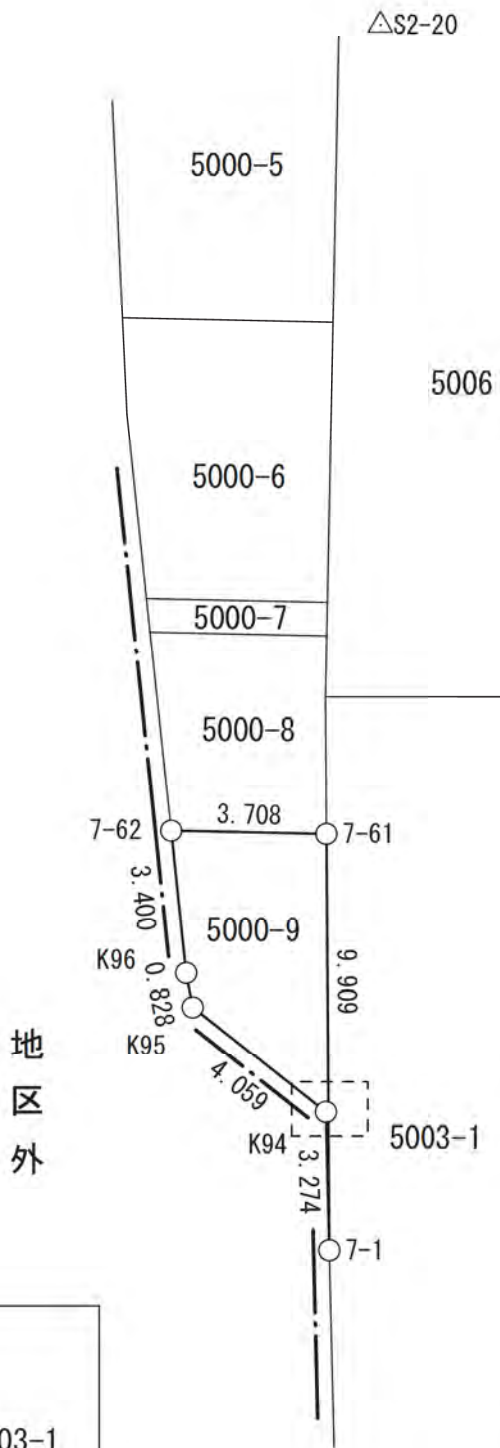

拡大図

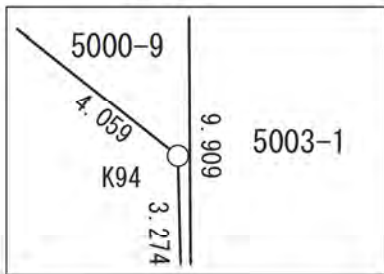

基準点網図

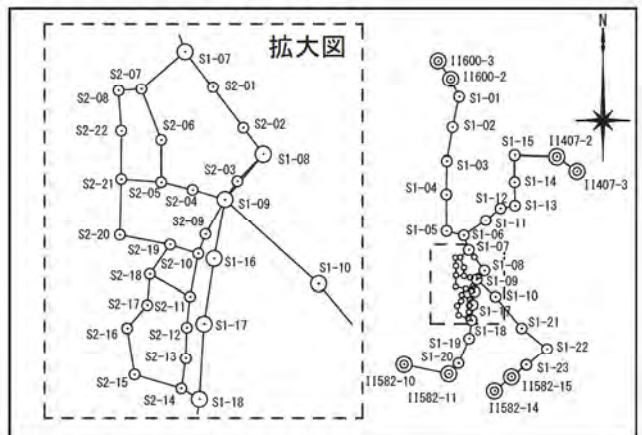

△ S2-18



地区外

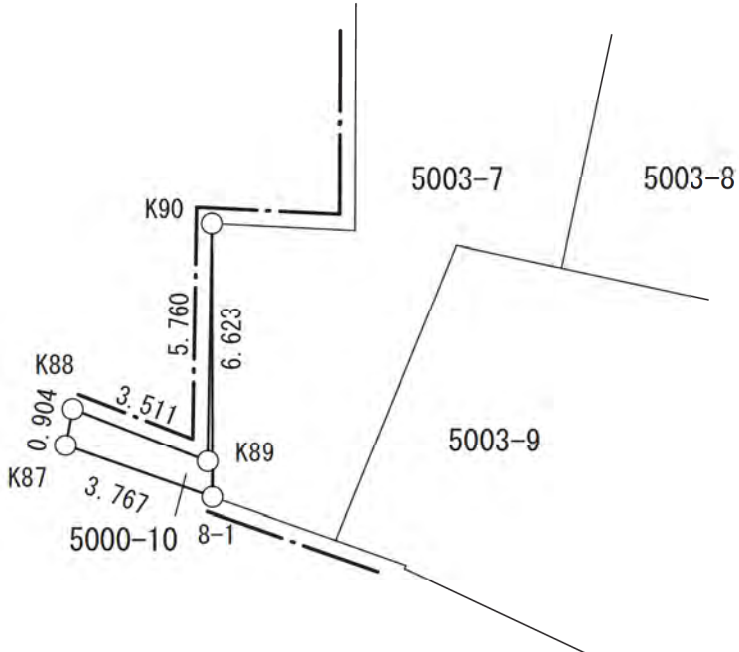

△ S2-17

基準点網図

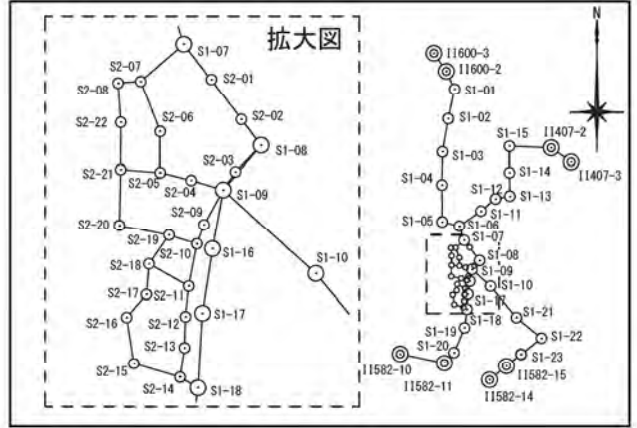

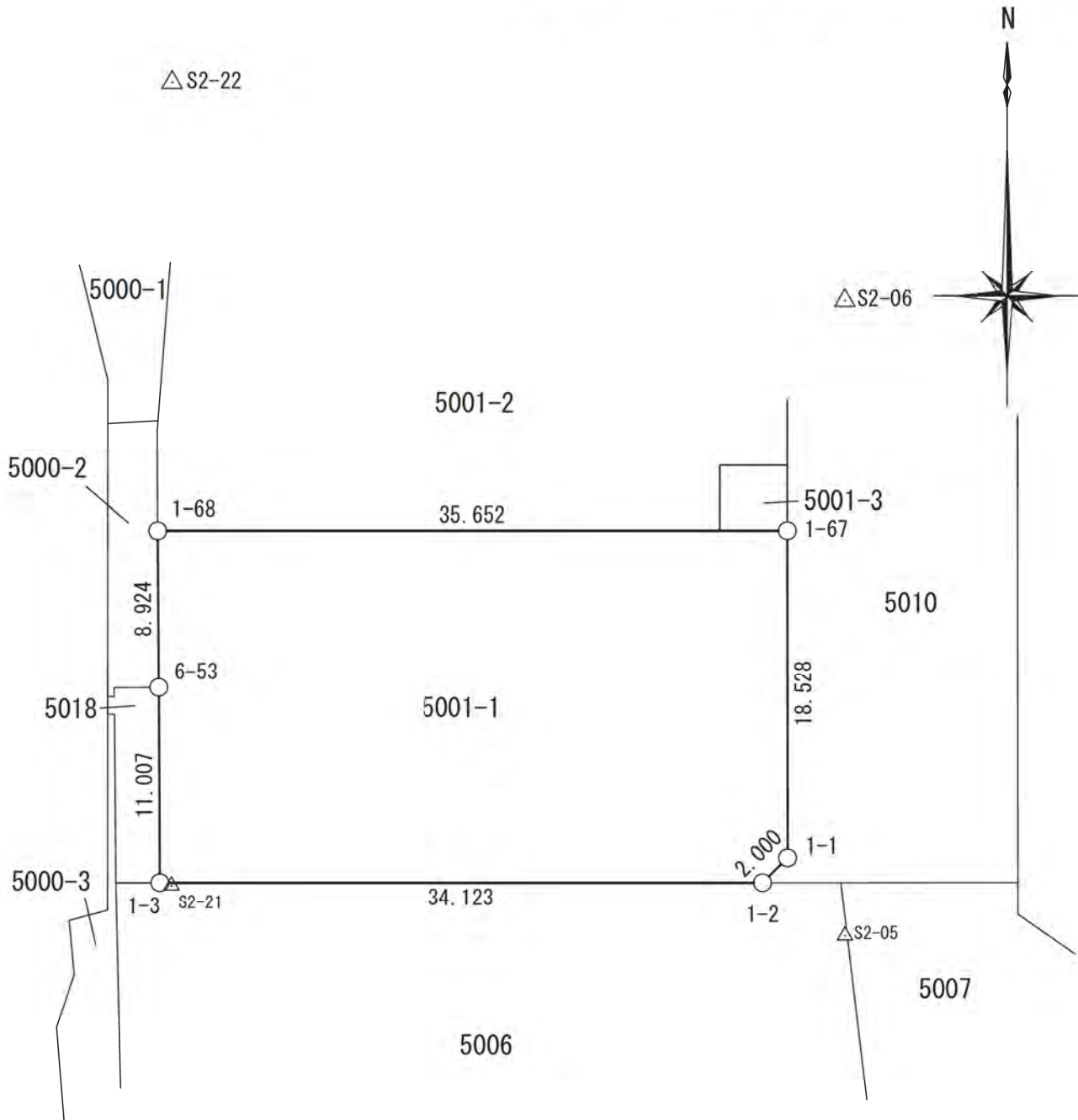

基準点網図

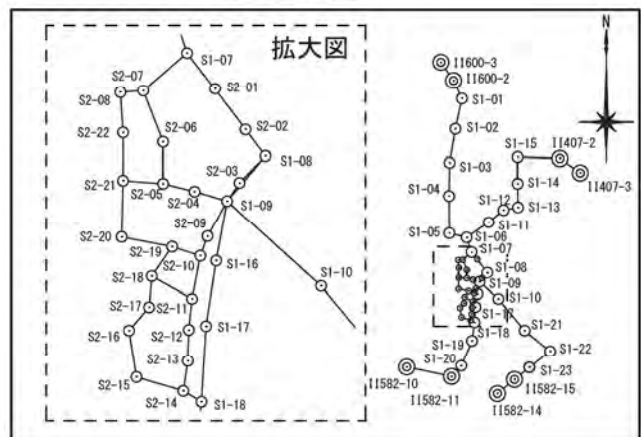

地番 5001-2

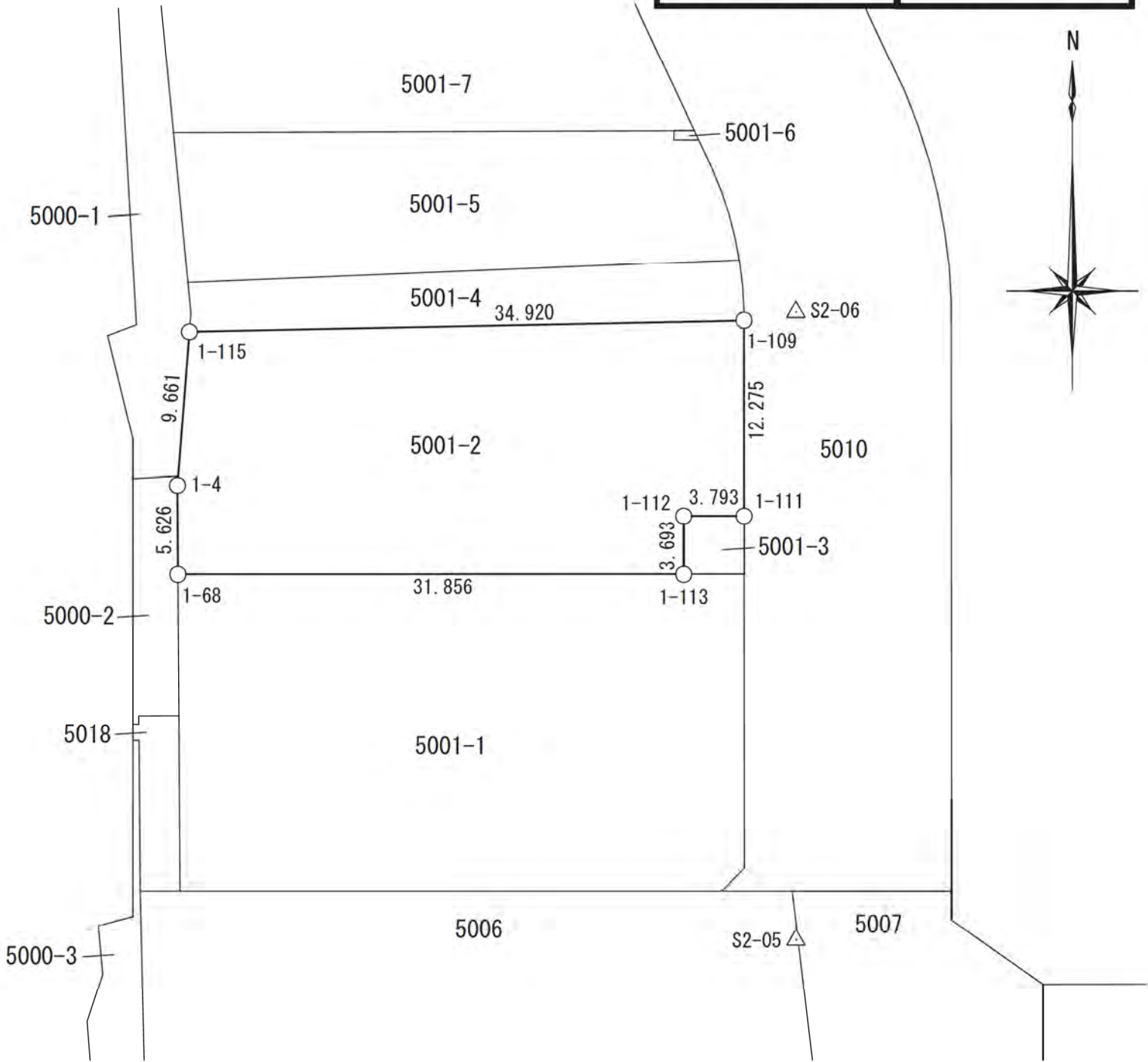

基準点網図

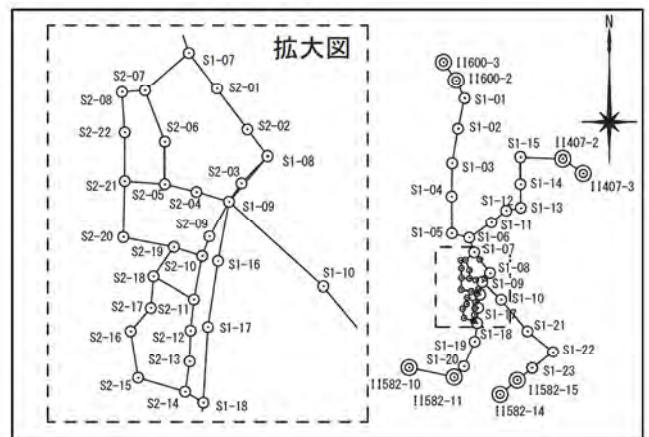

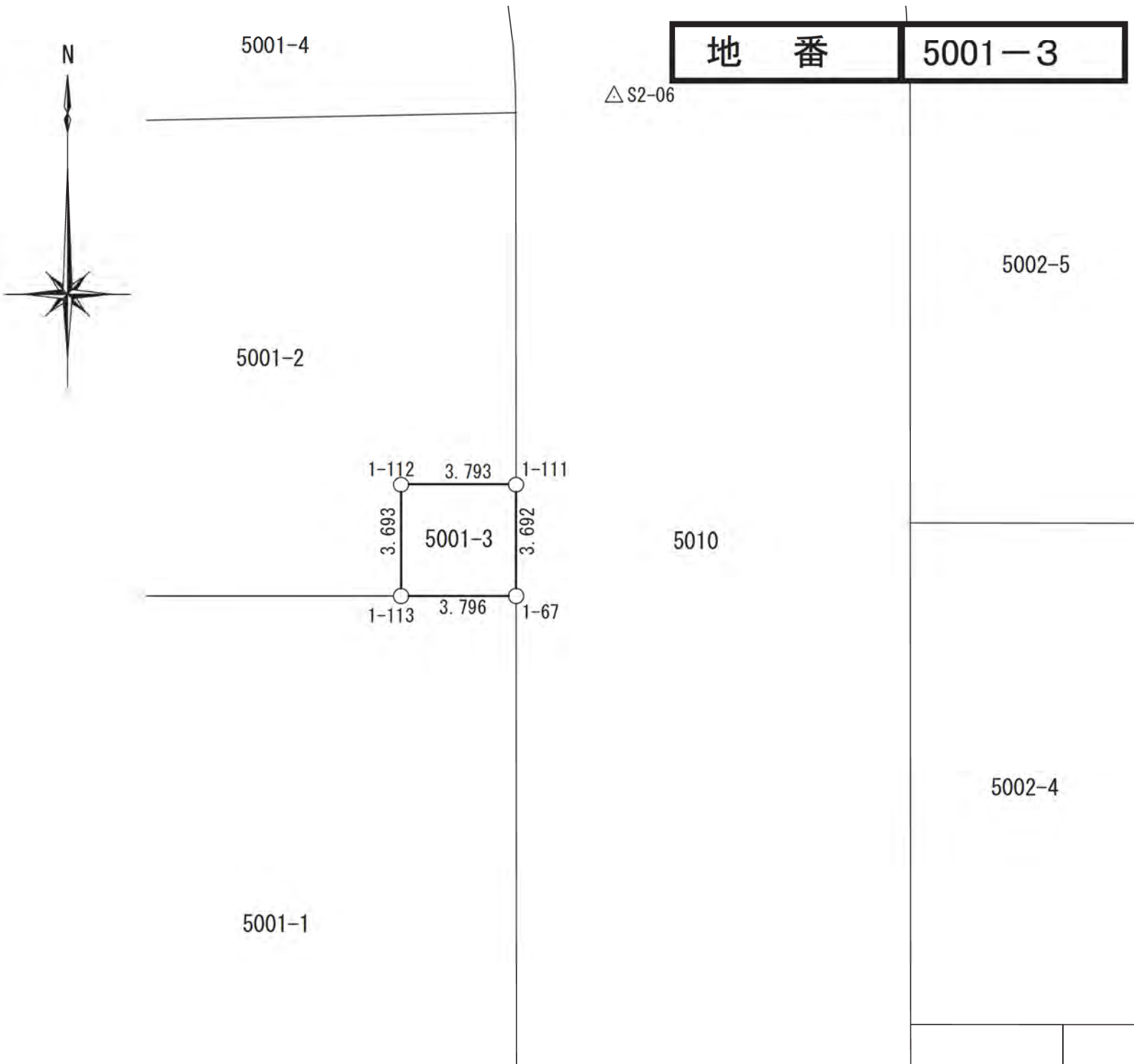

基準点網図

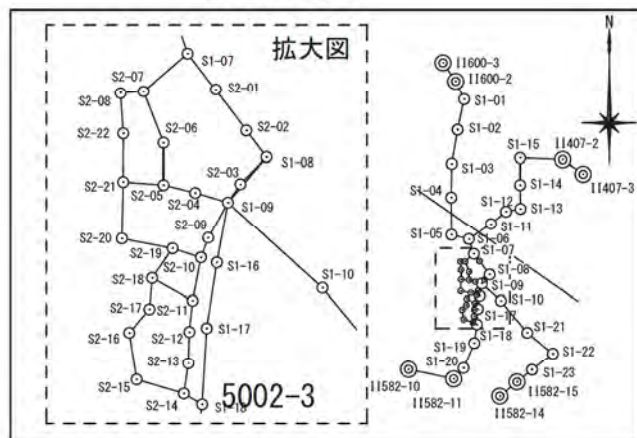

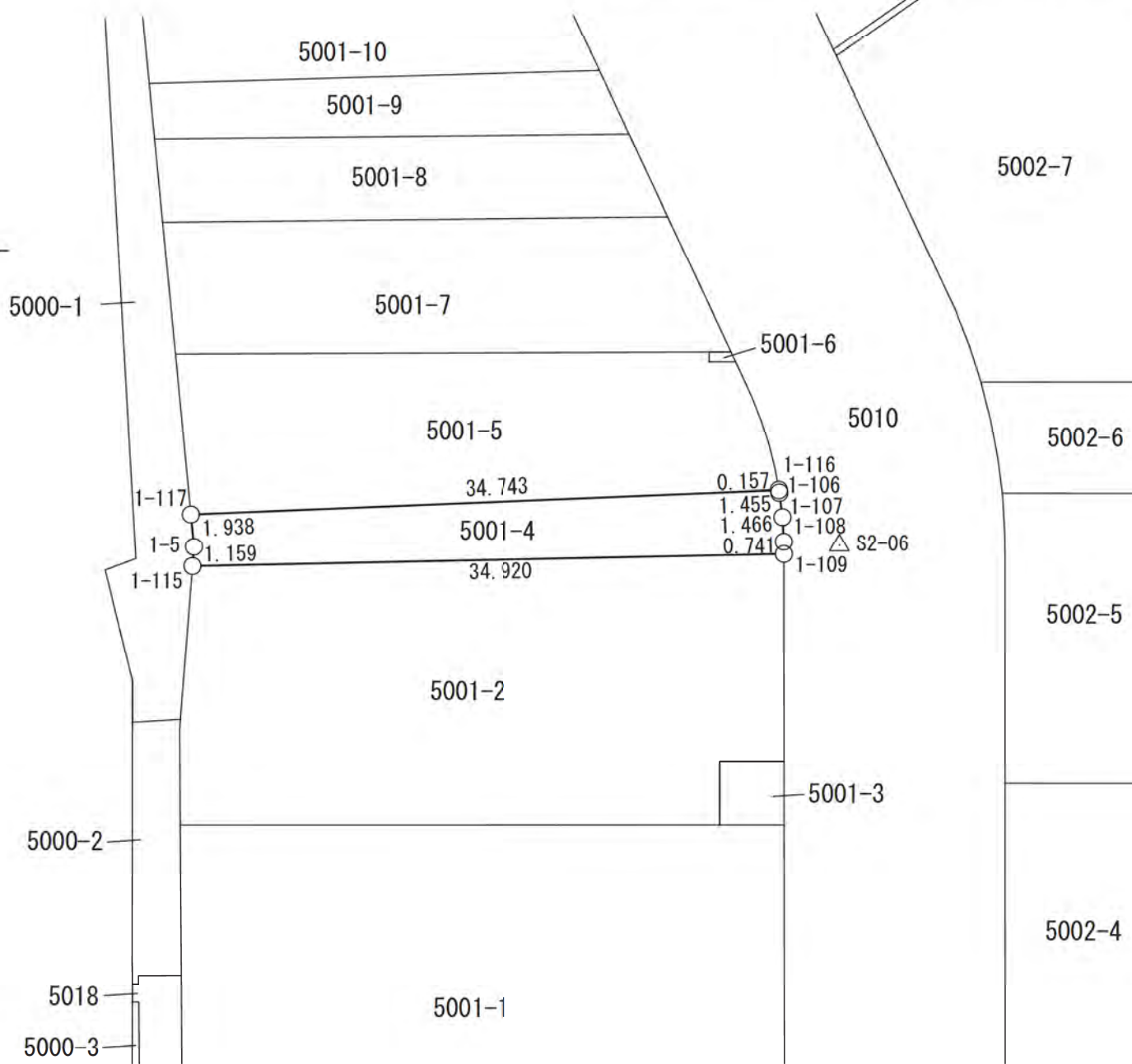

基準点網図

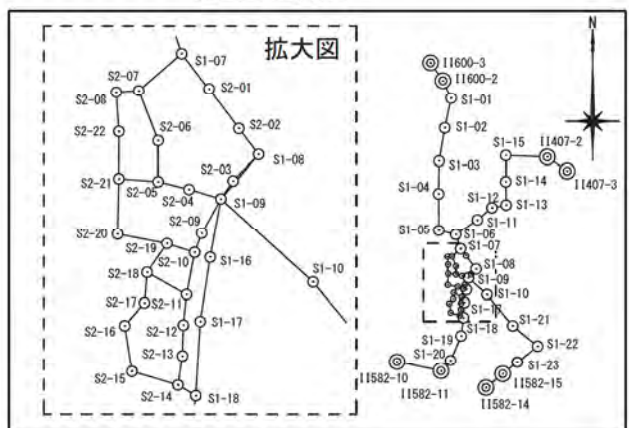

地 番

5001-5

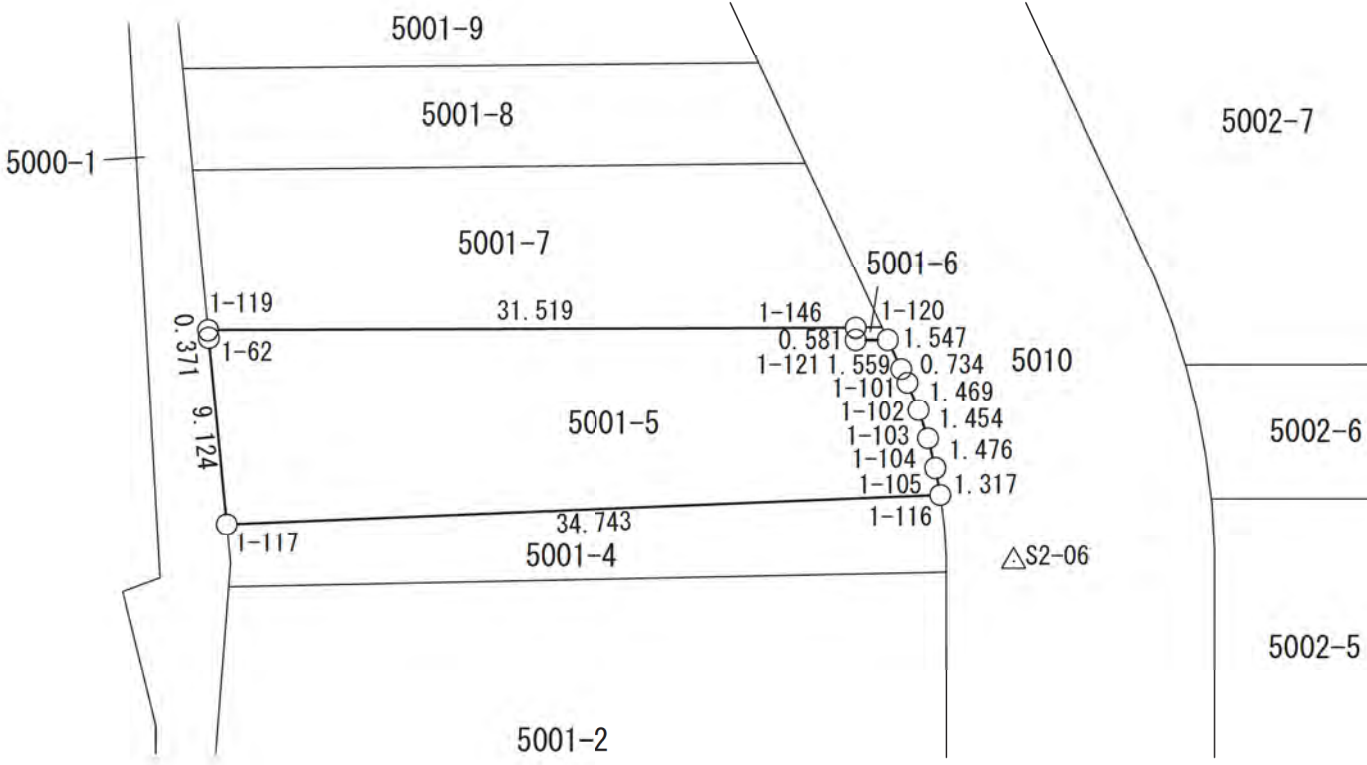

基準点網図

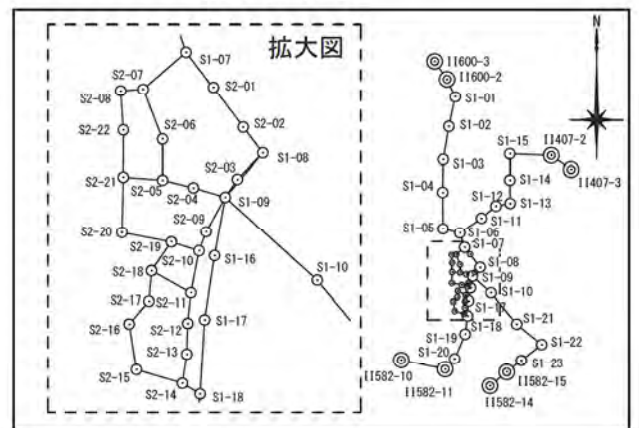

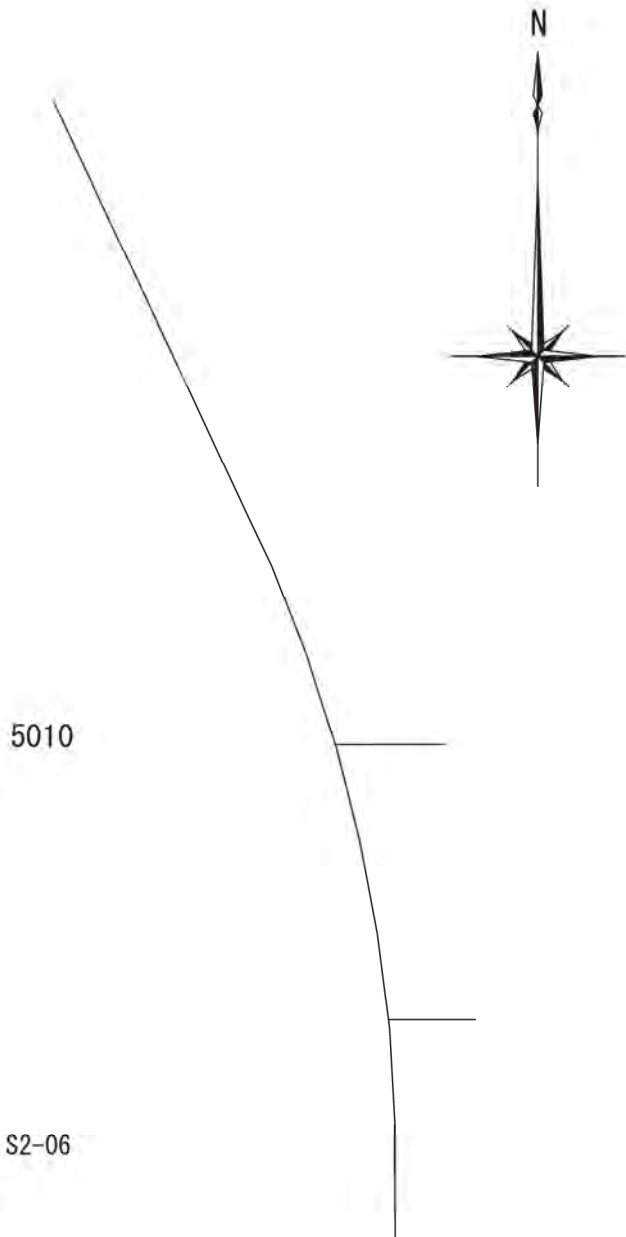
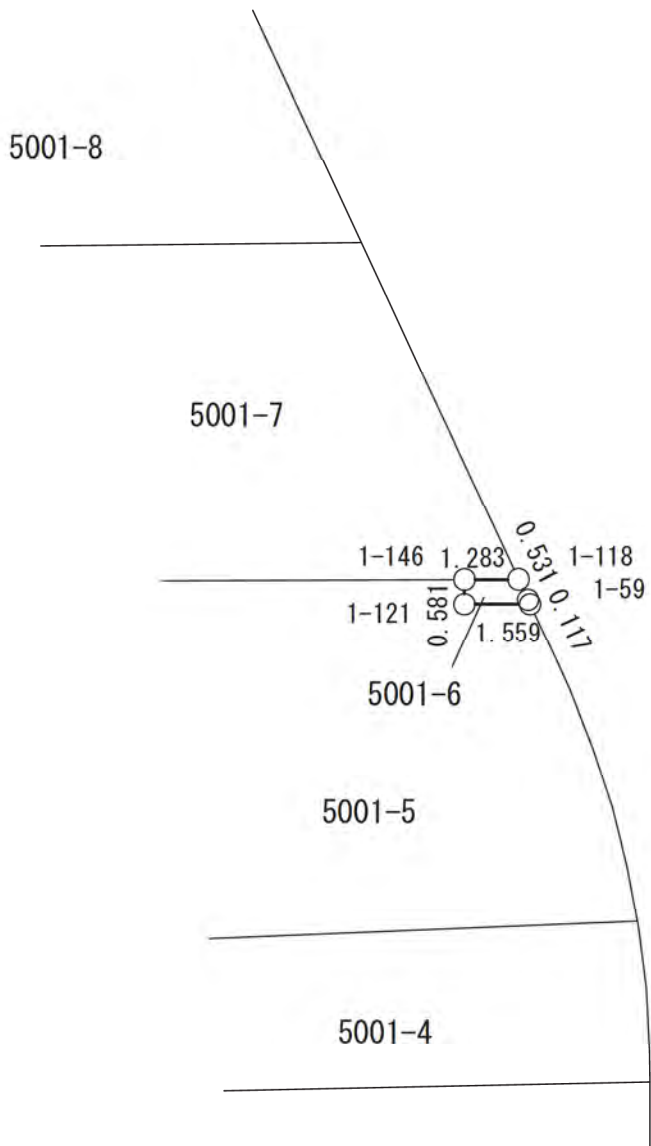

基準点網図

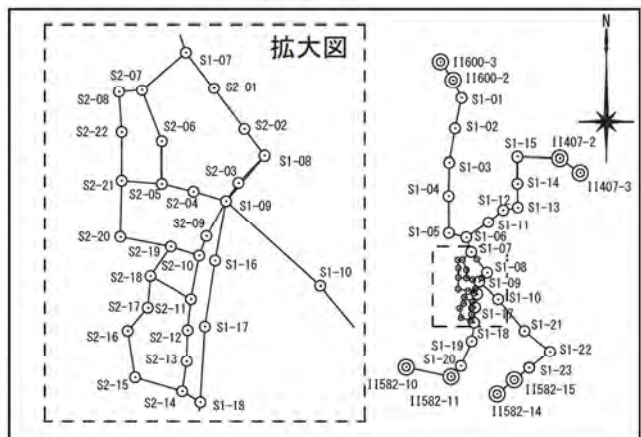

△ S2-07

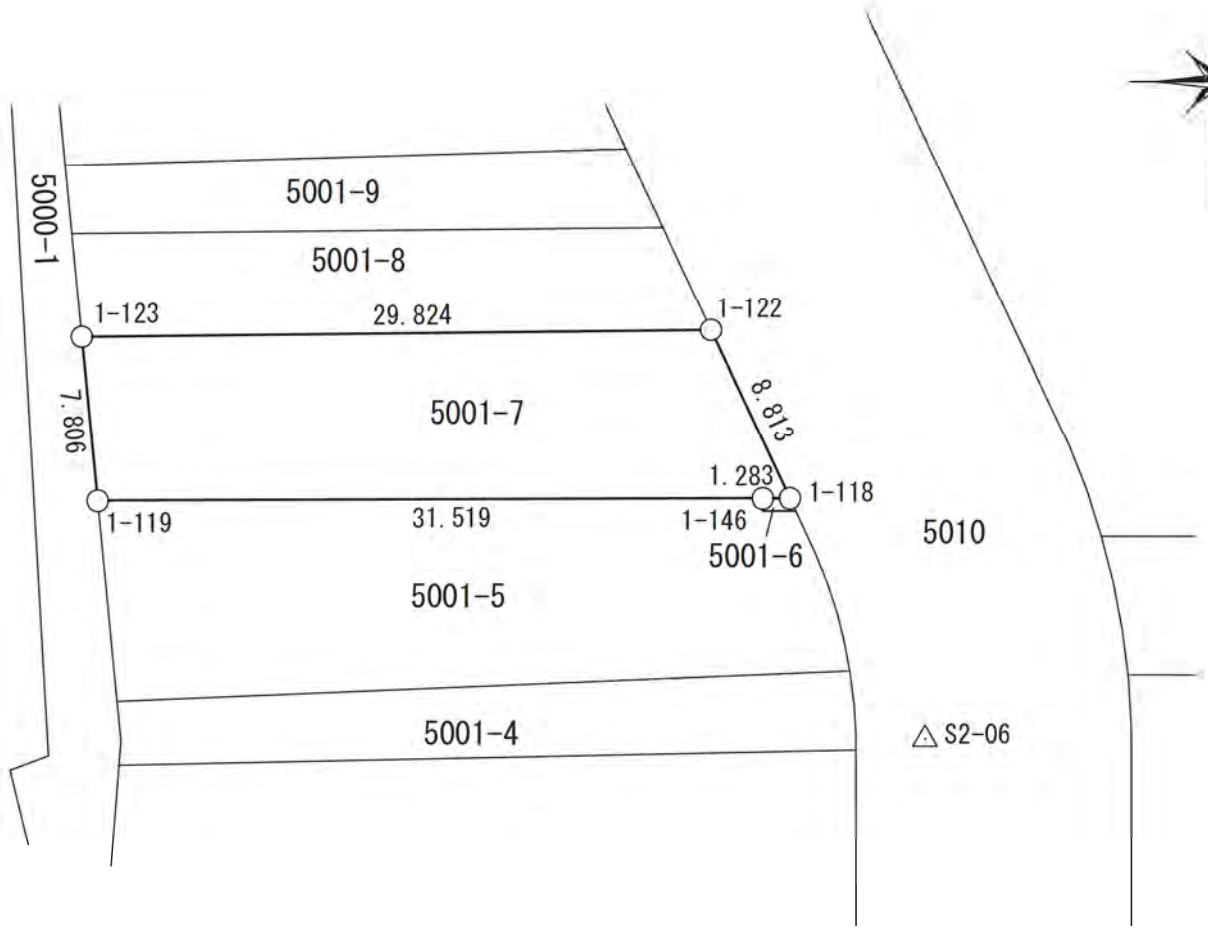

基準点網図

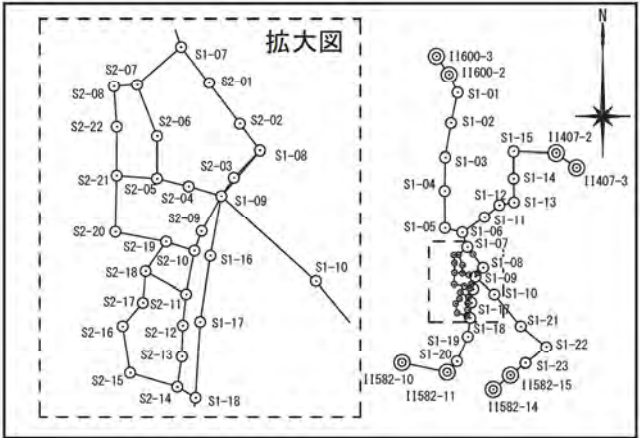

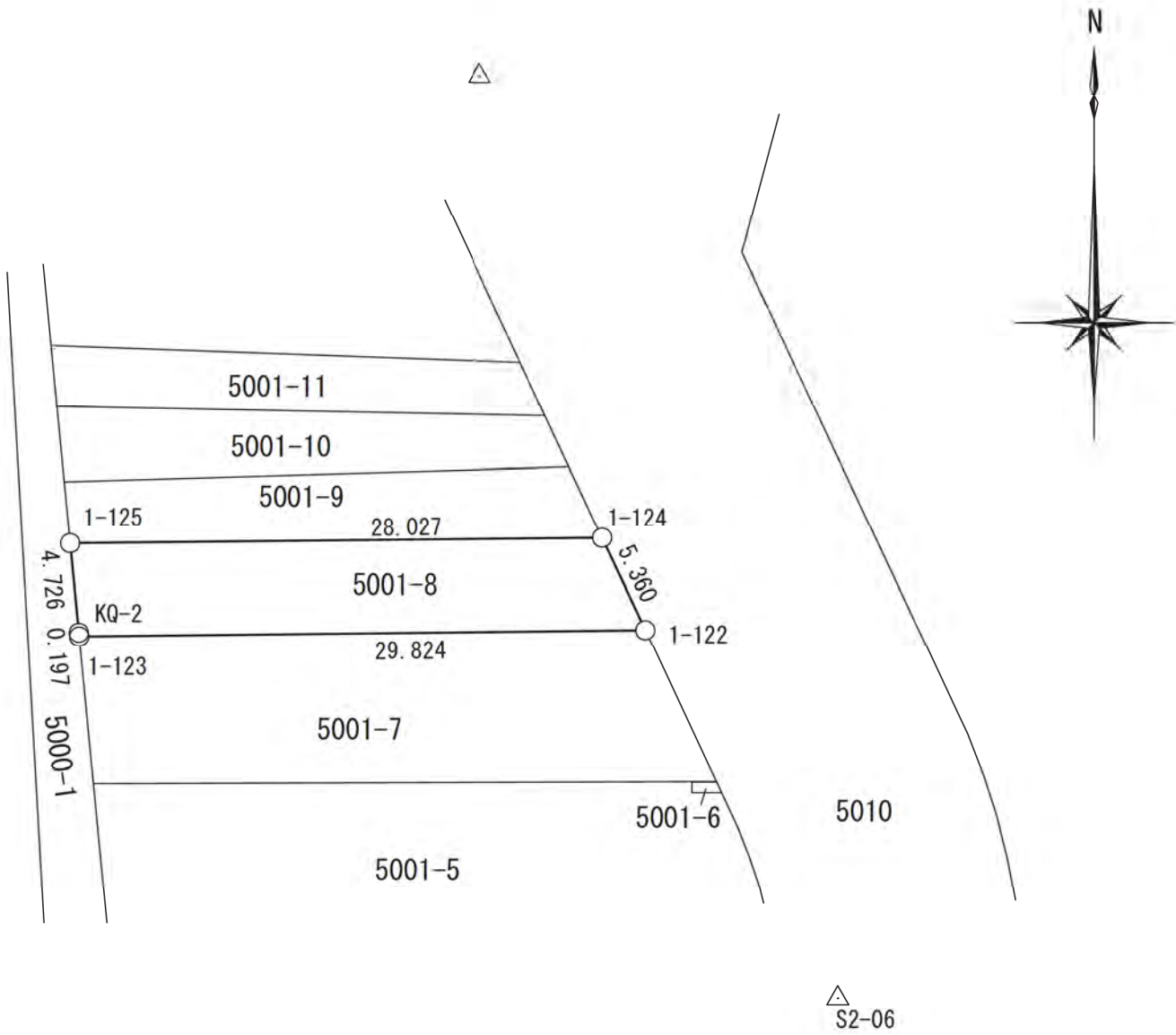

△ S2-06

基準点網図

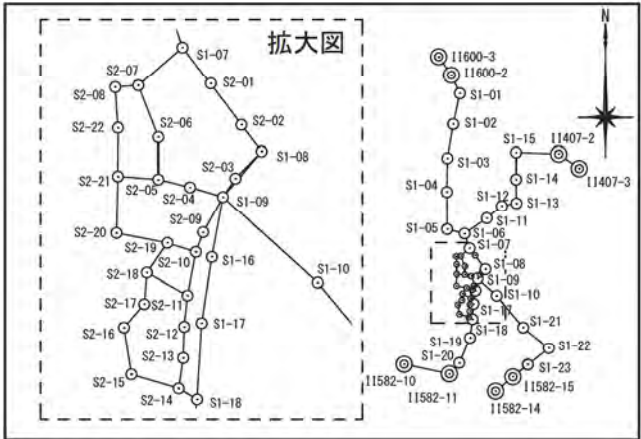

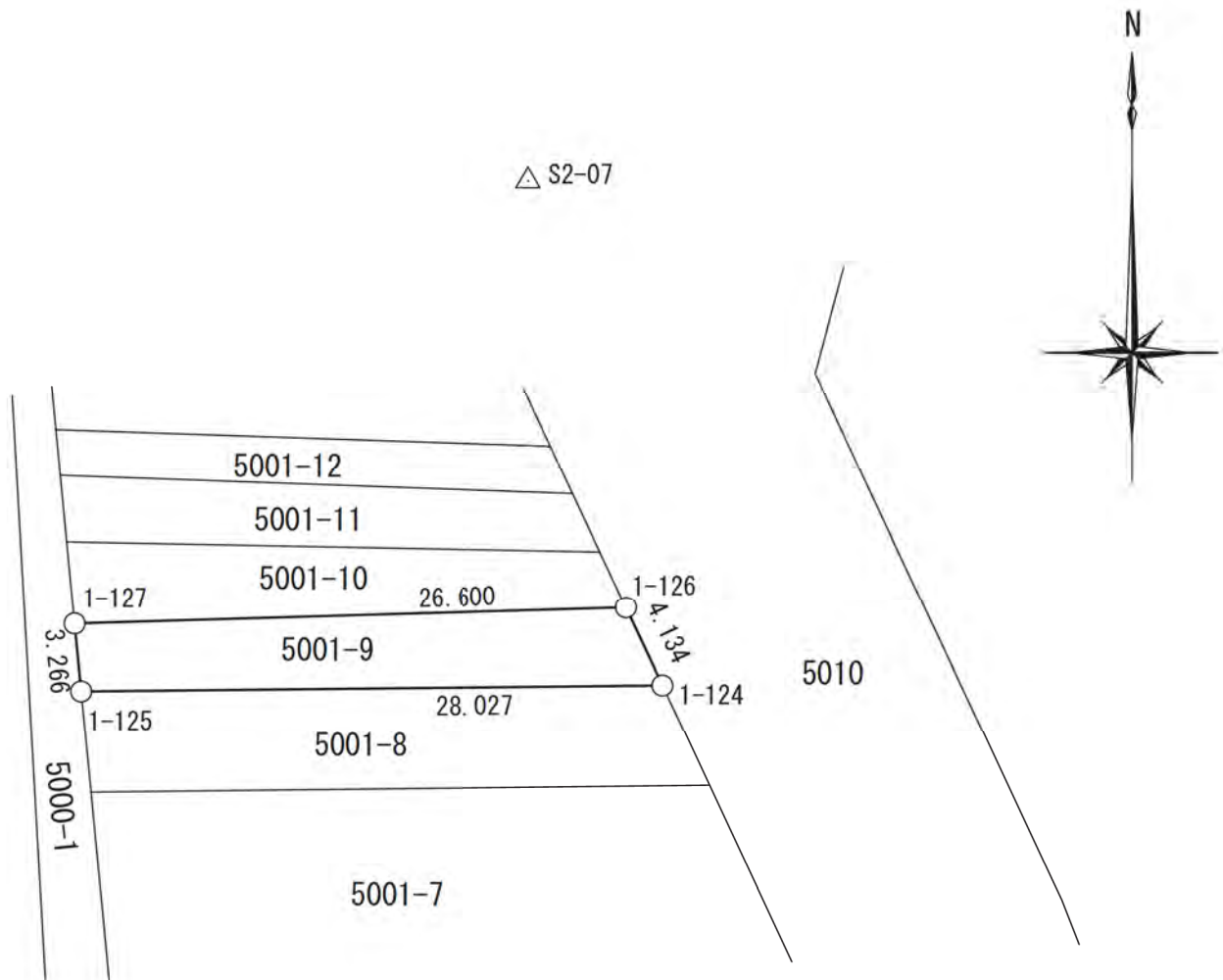

△ S2-07

△ S2-06

基準点網図

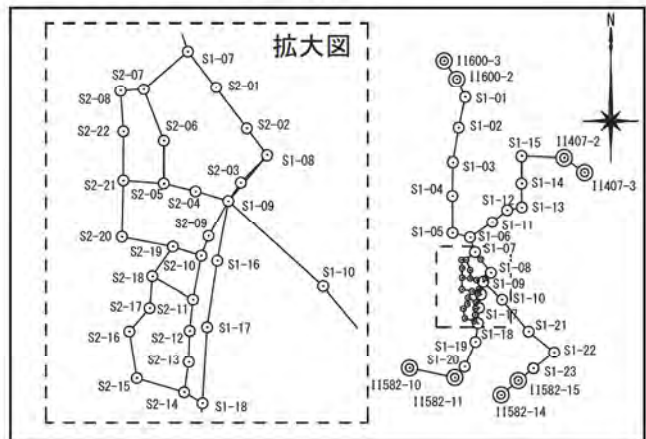

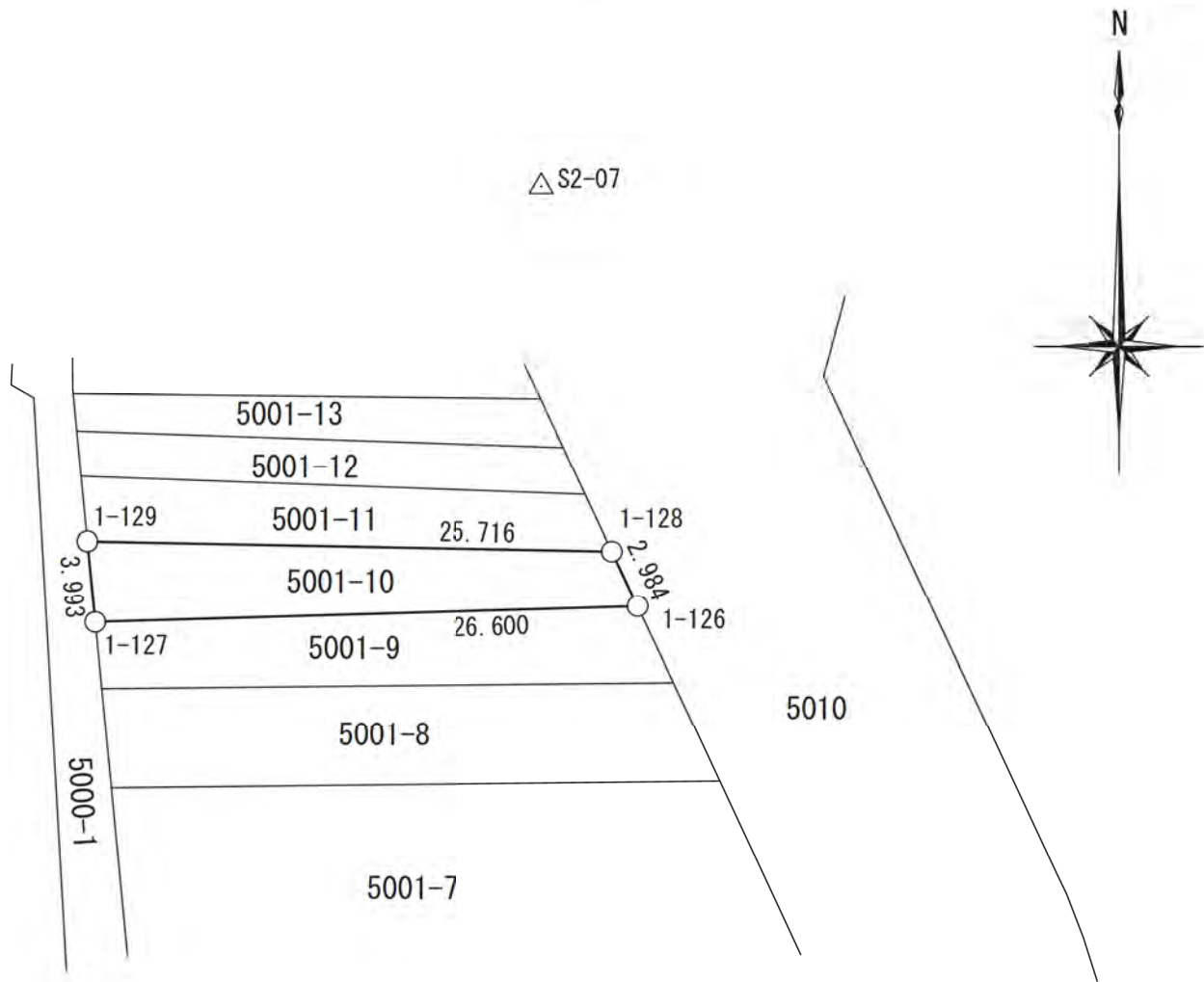

△S2-06

基準点網図

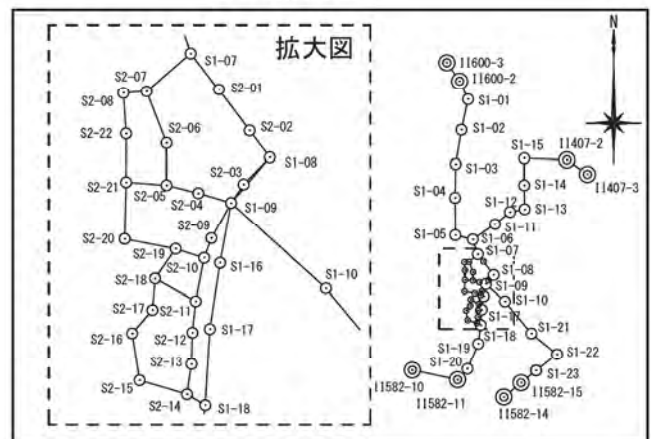

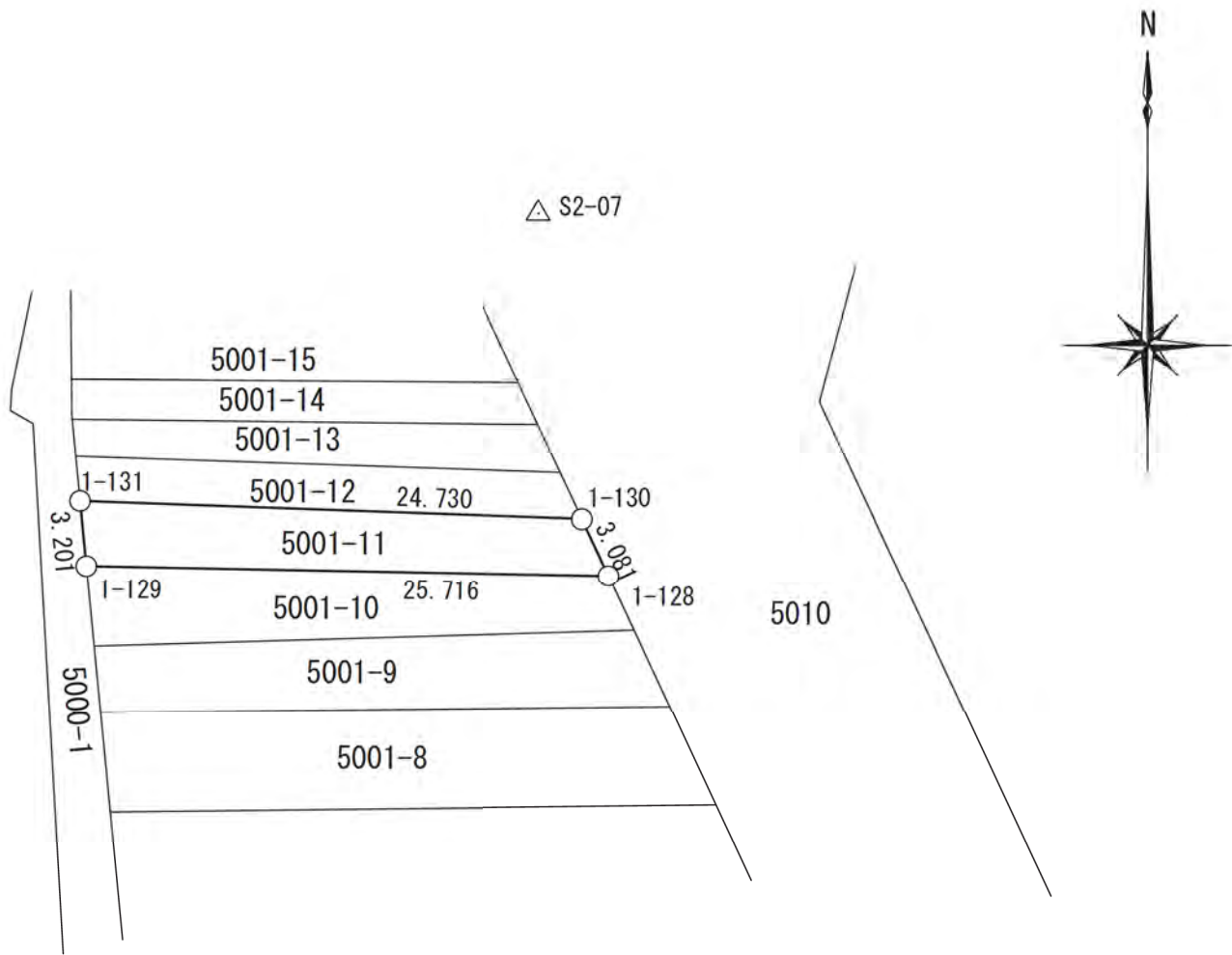

△ S2-06

基準点網図

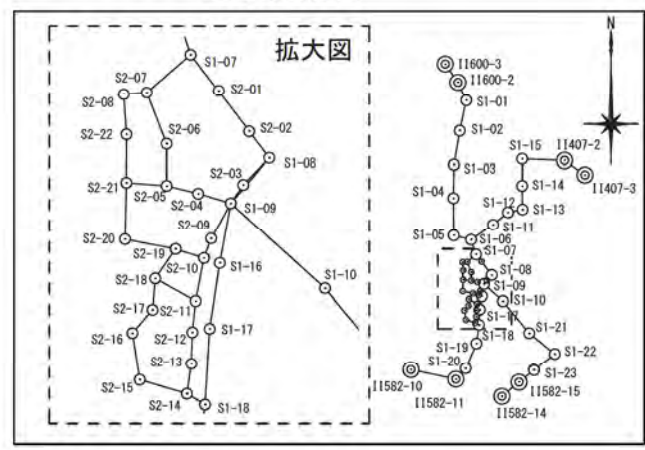

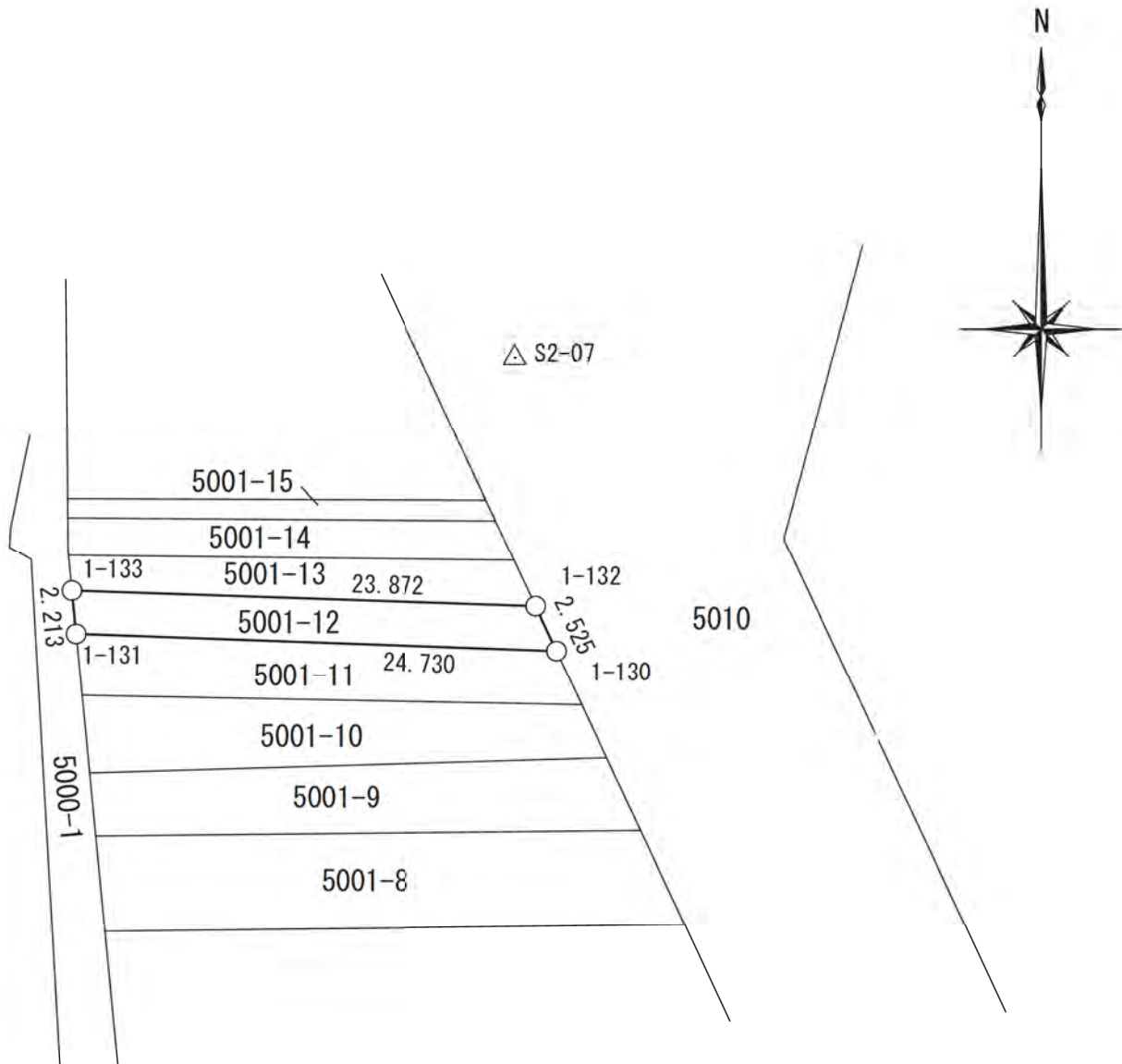

基準点網図

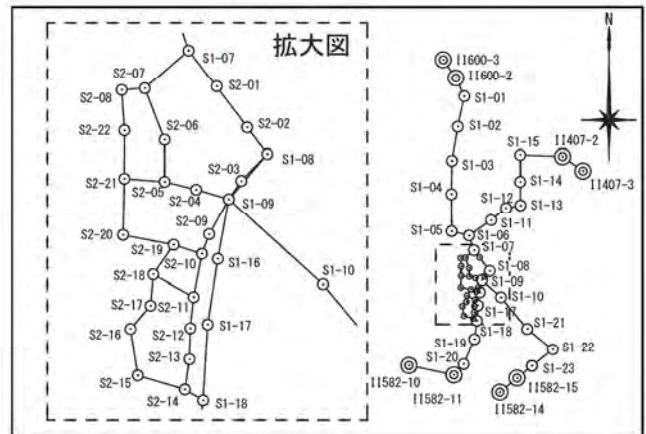

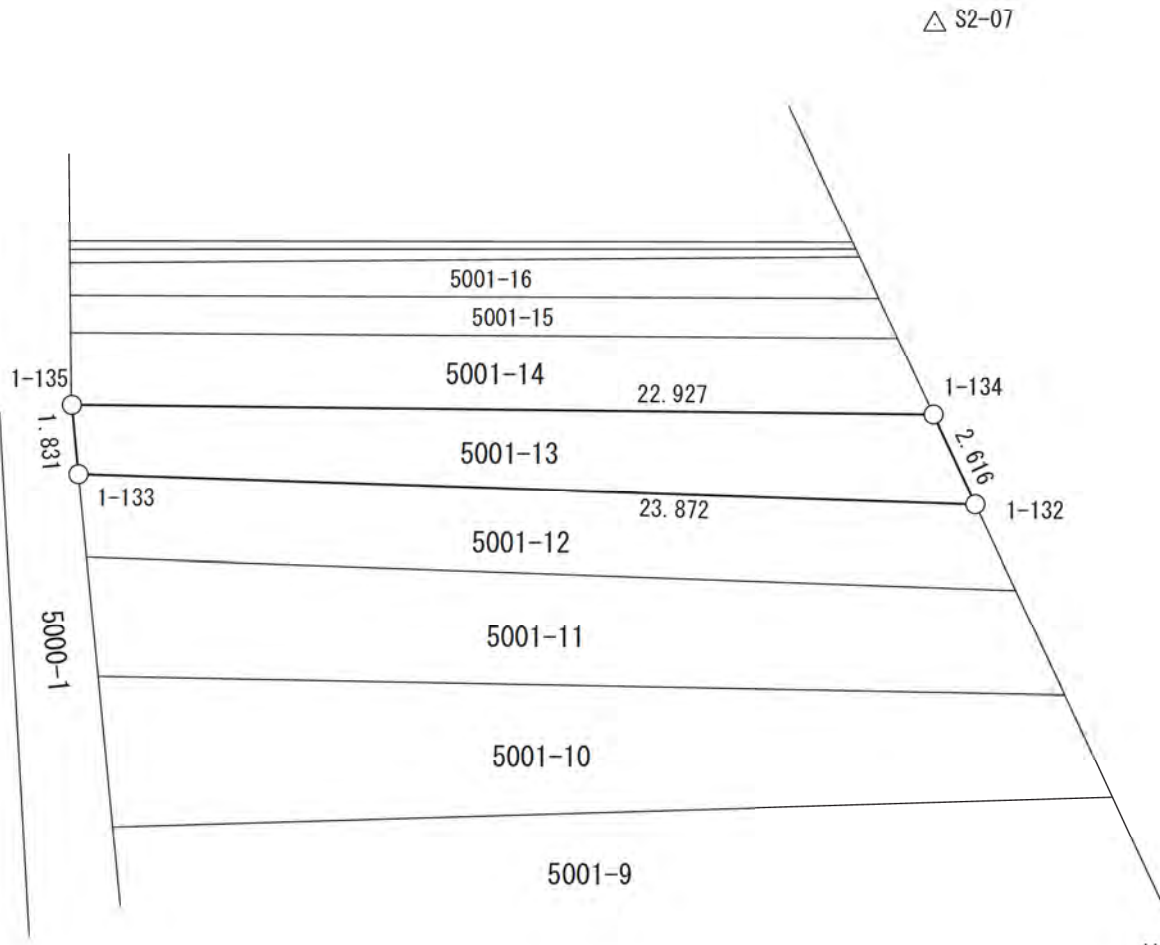

基準点網図

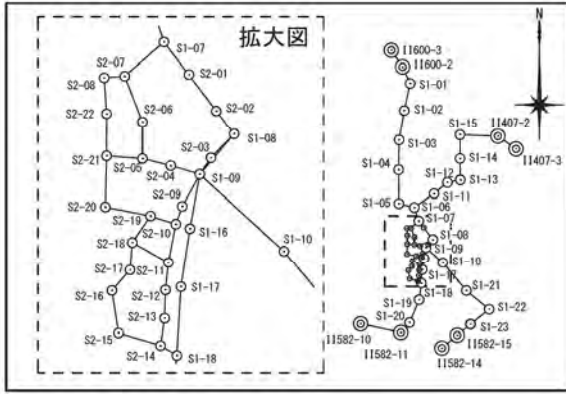

地番 5001-14

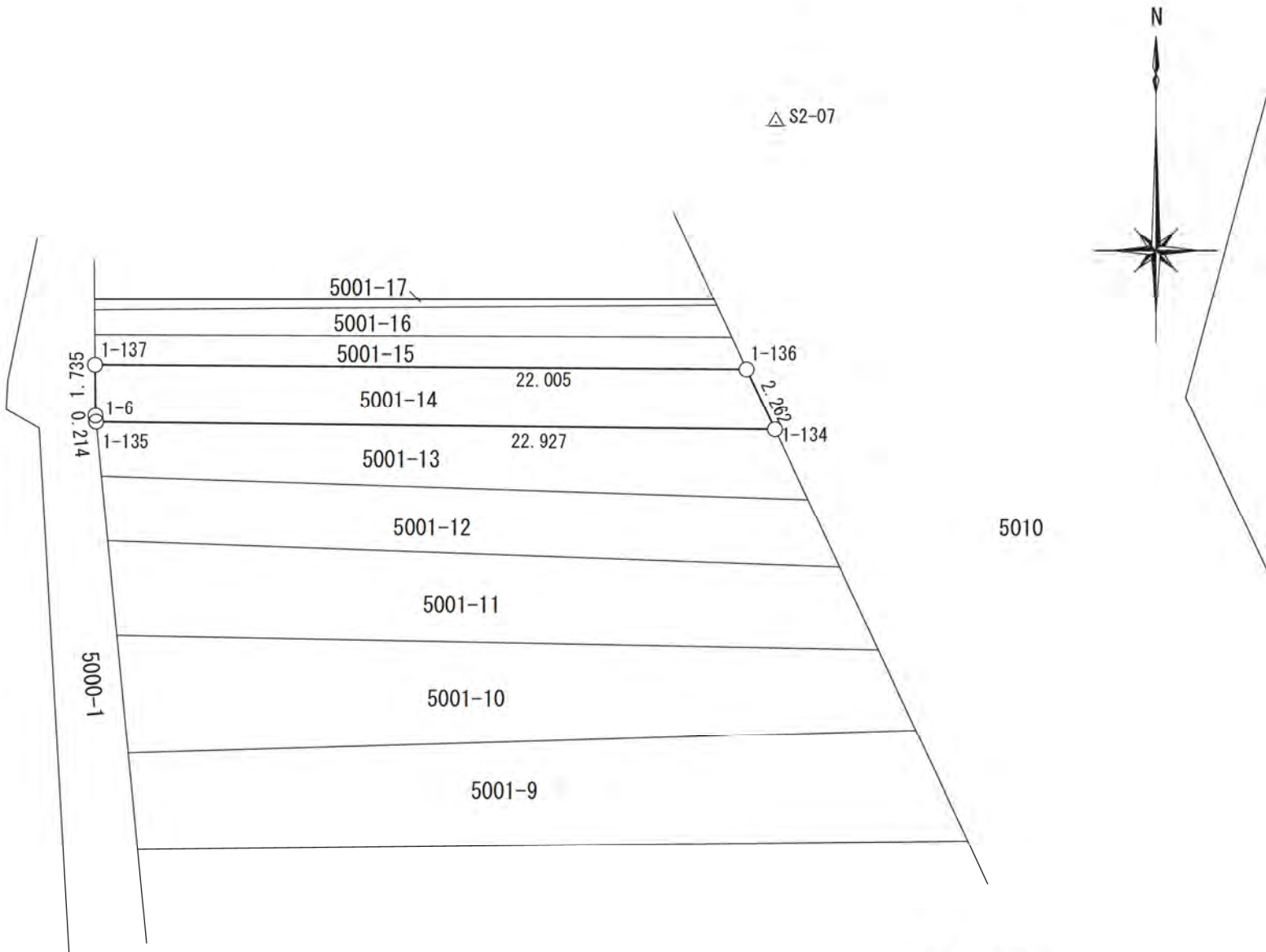

基準点網図

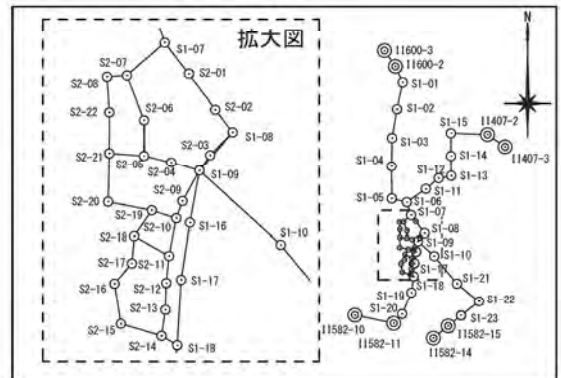

地番 5001-15

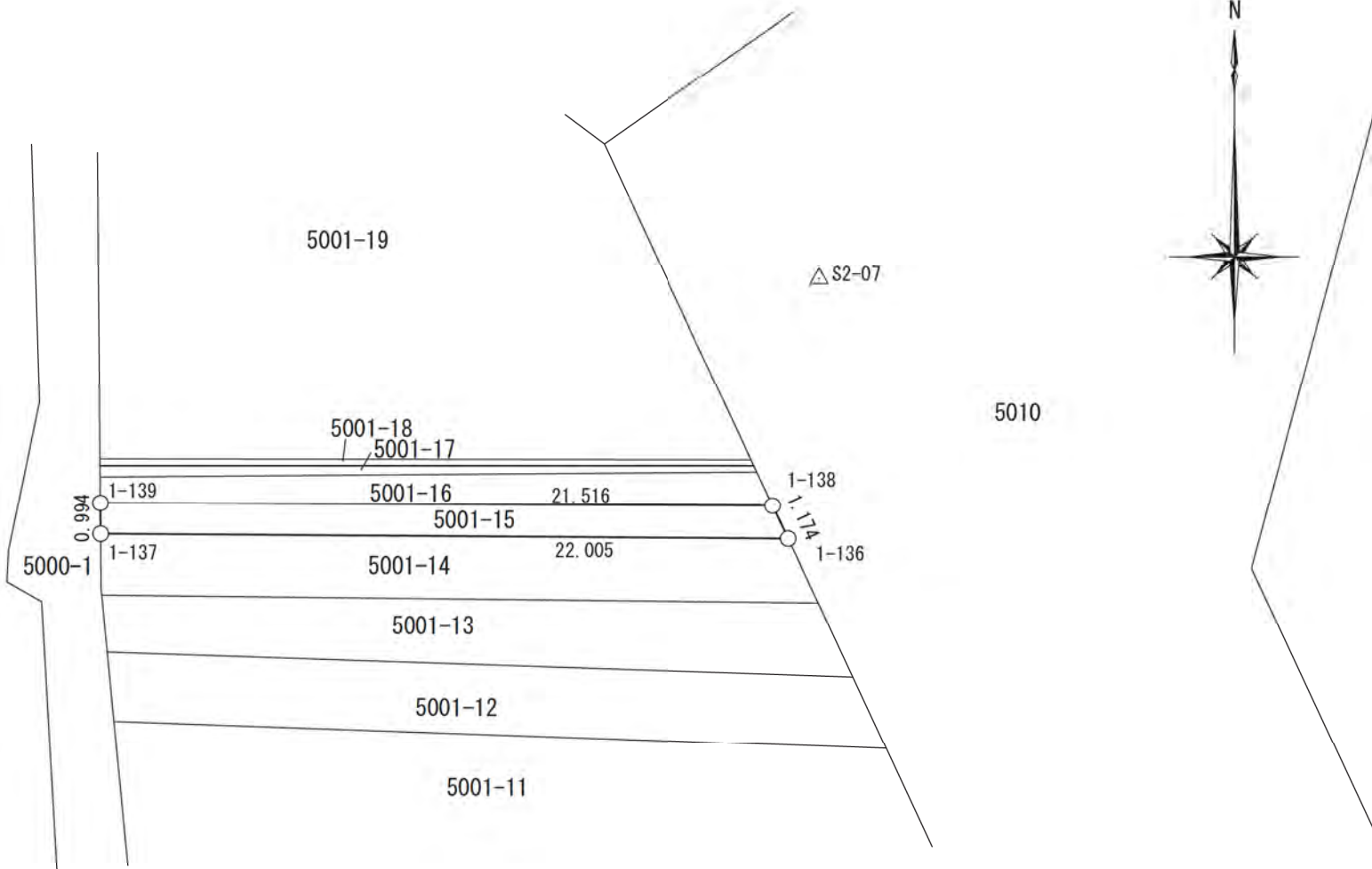

基準点網図

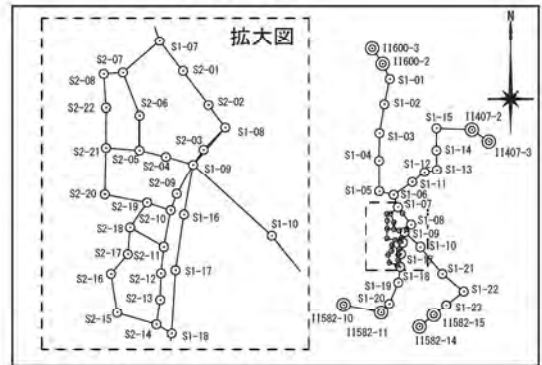

地番	5001-16
----	---------

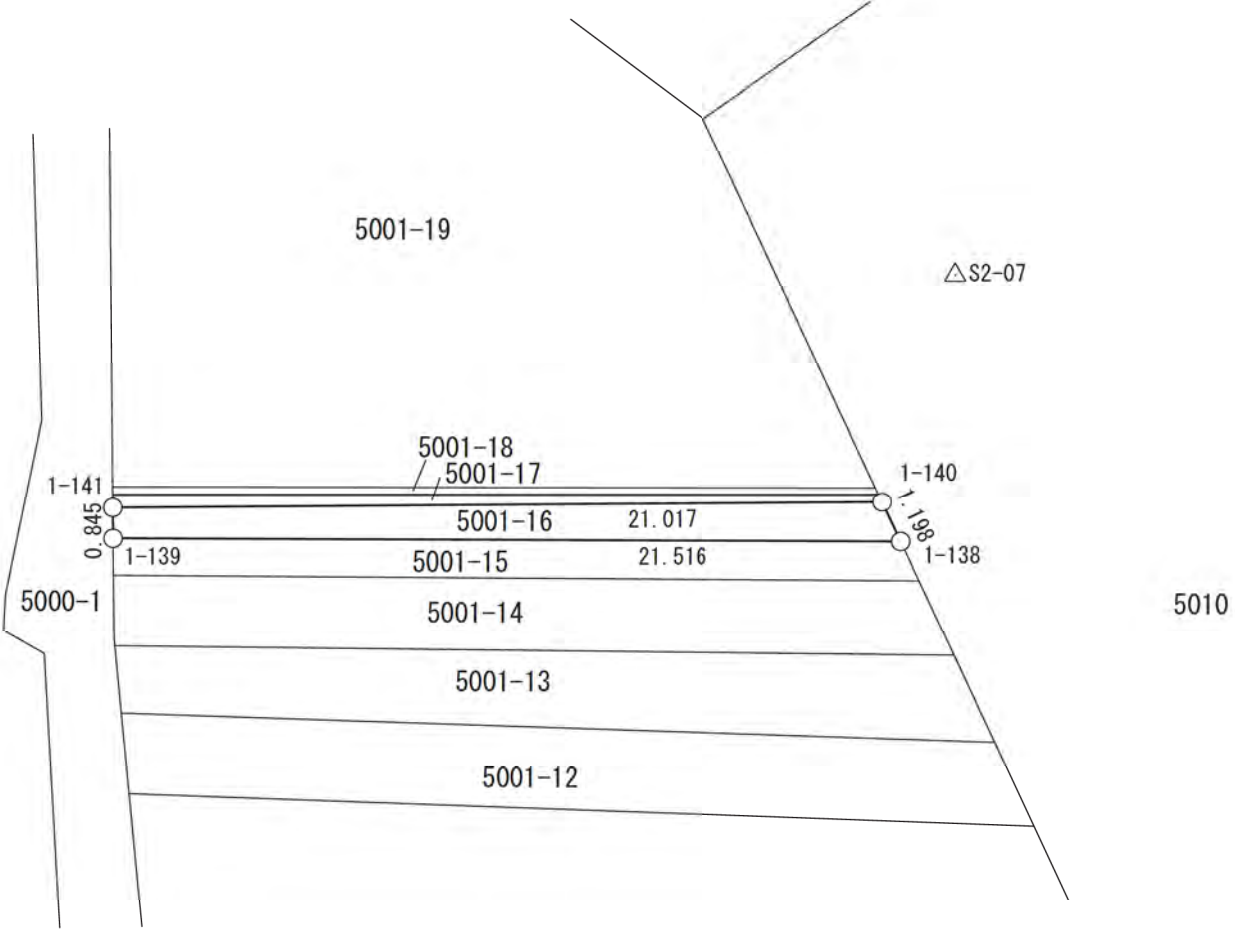

基準点網図

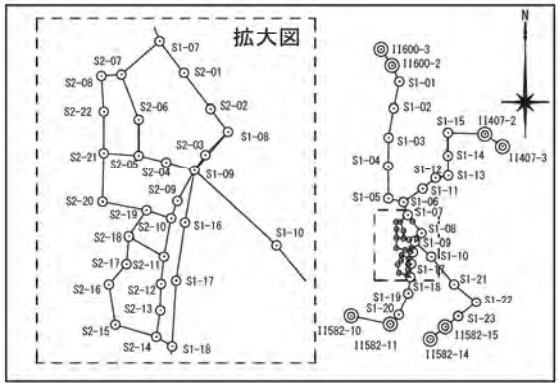

地番	5001-17
----	---------

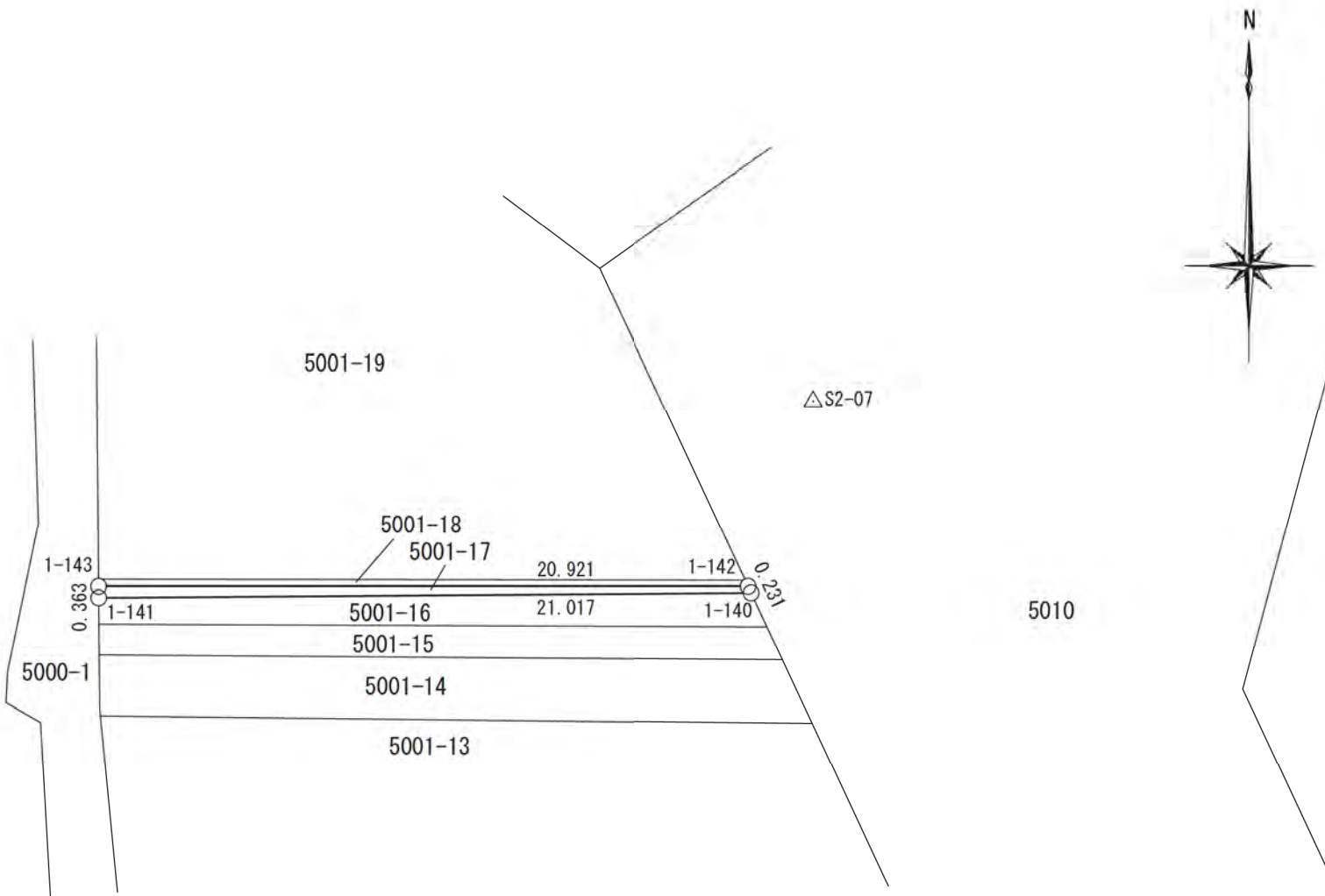

基準点網図

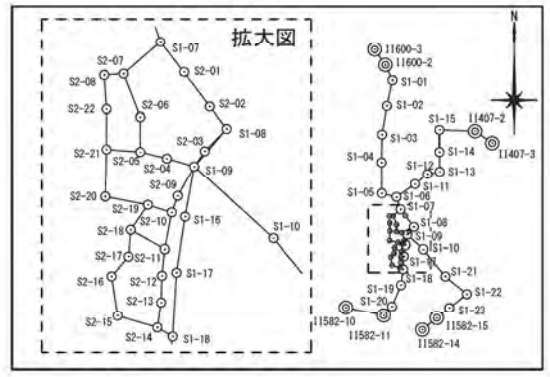

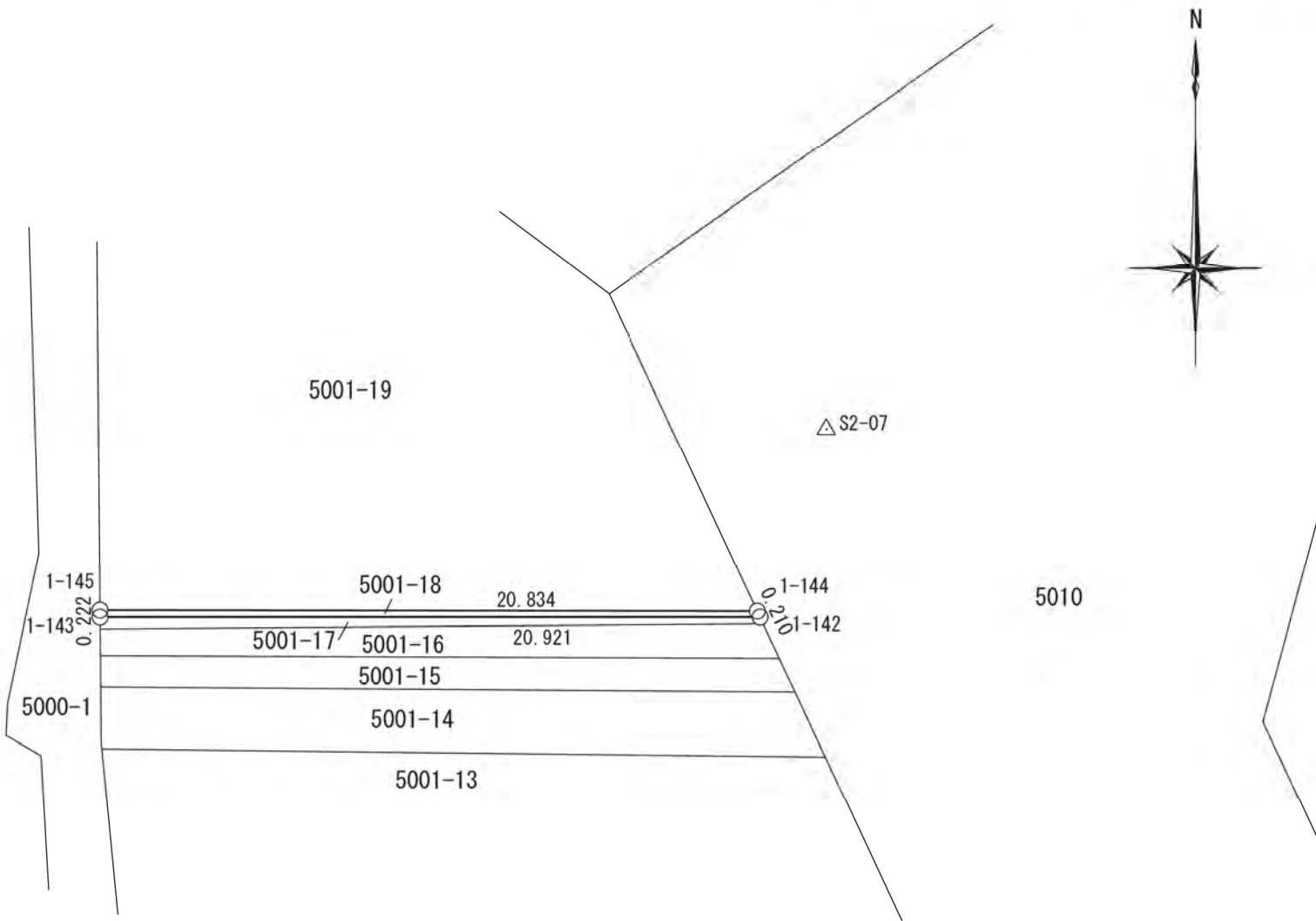

基準点網図

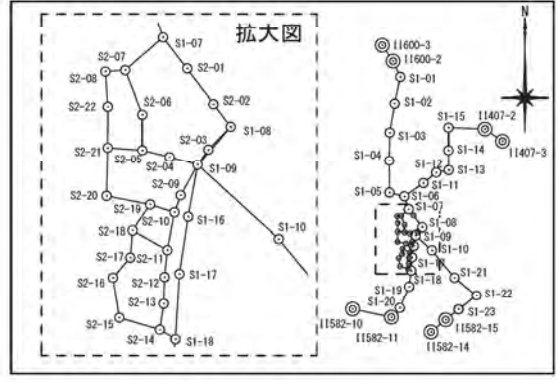

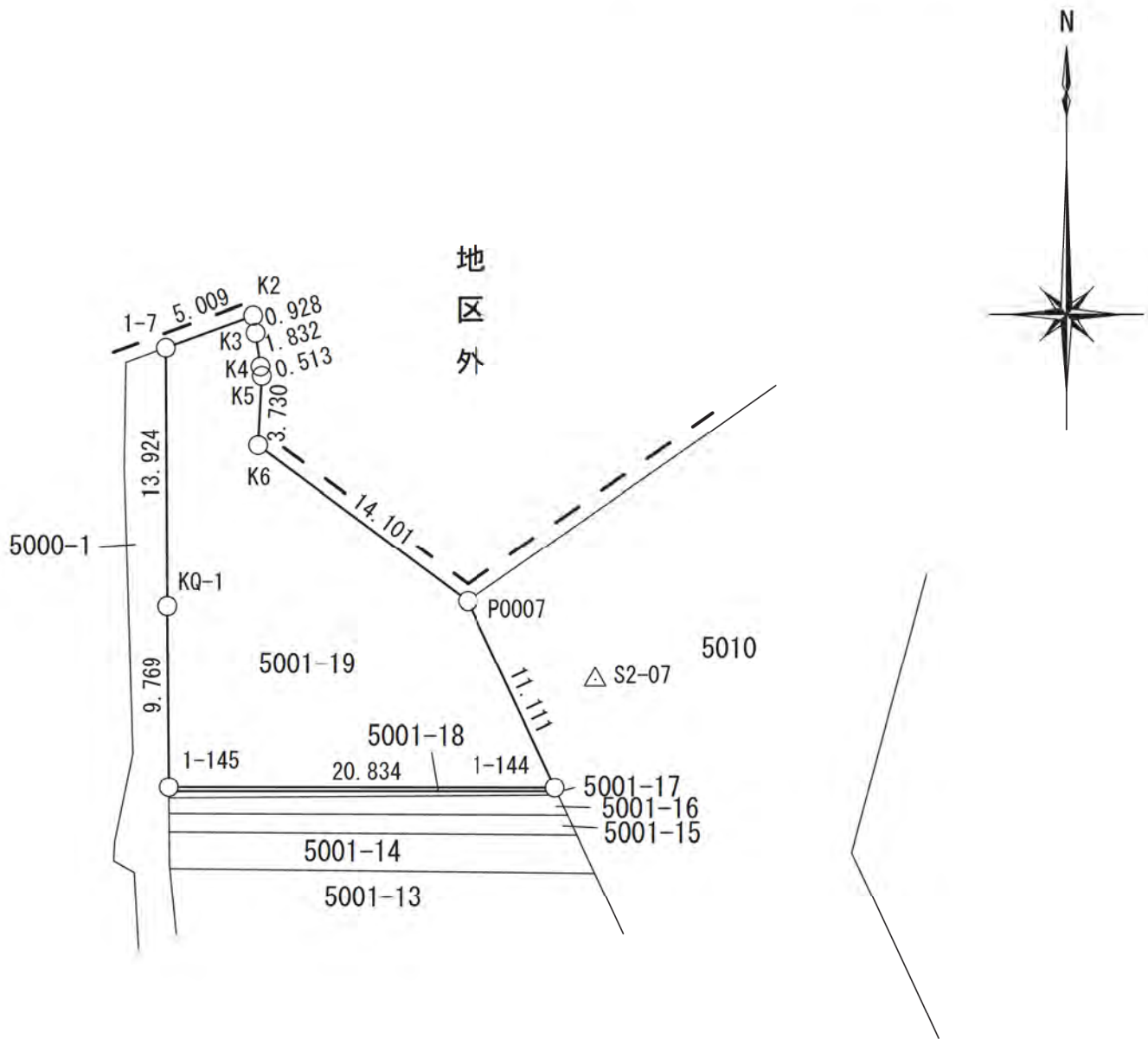

基準点網図

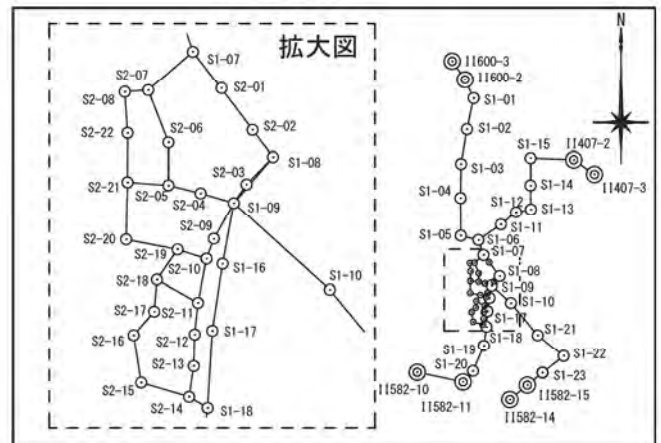

地 番 5002-1

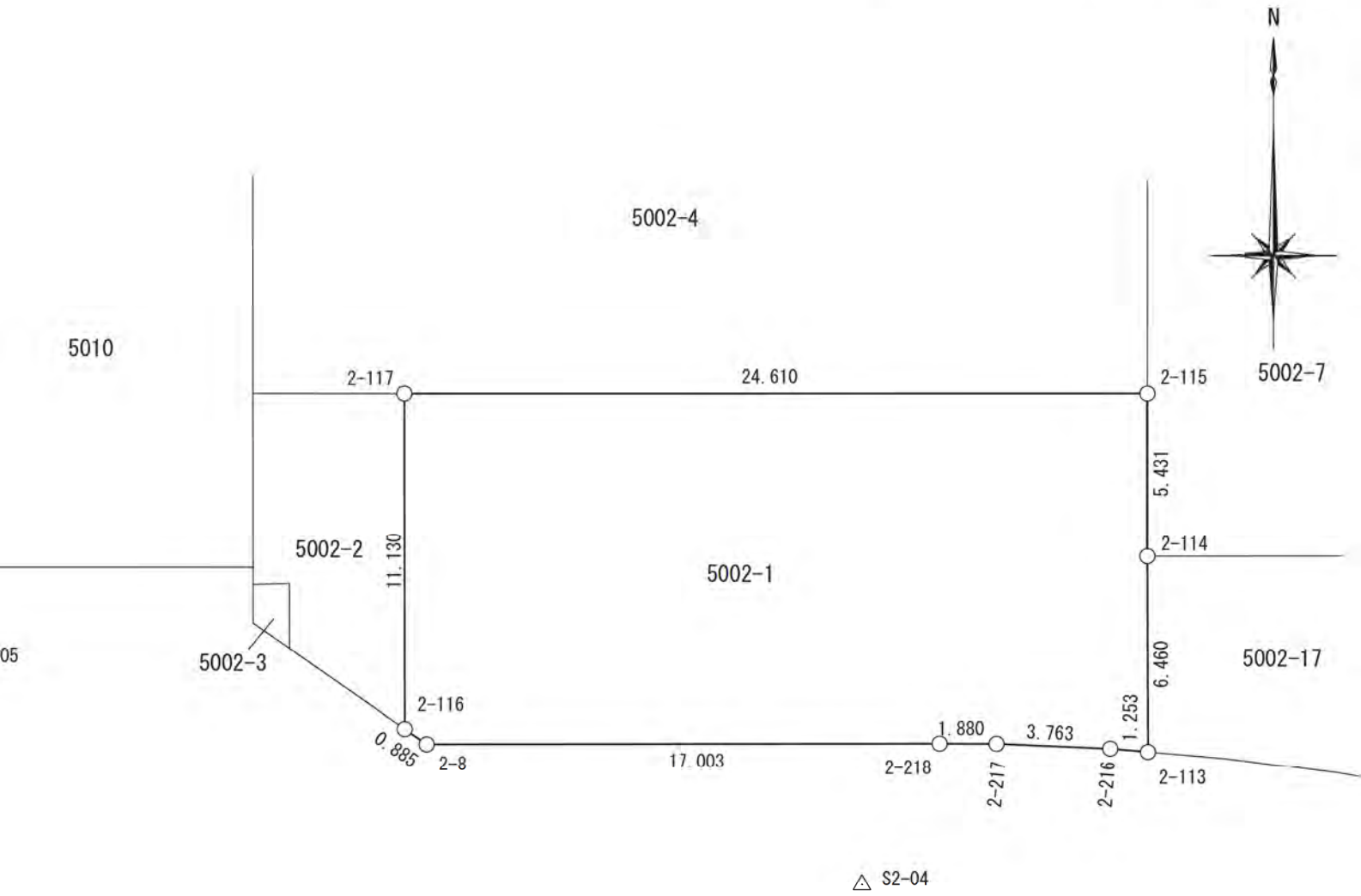

基準点網図

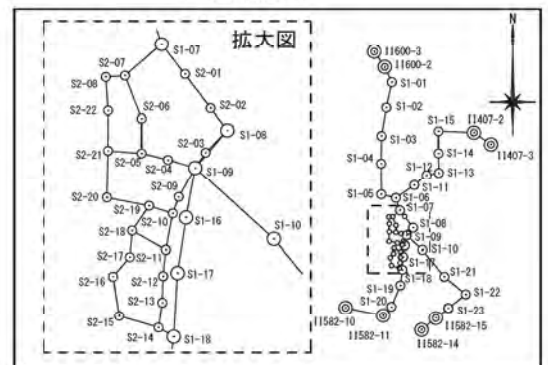

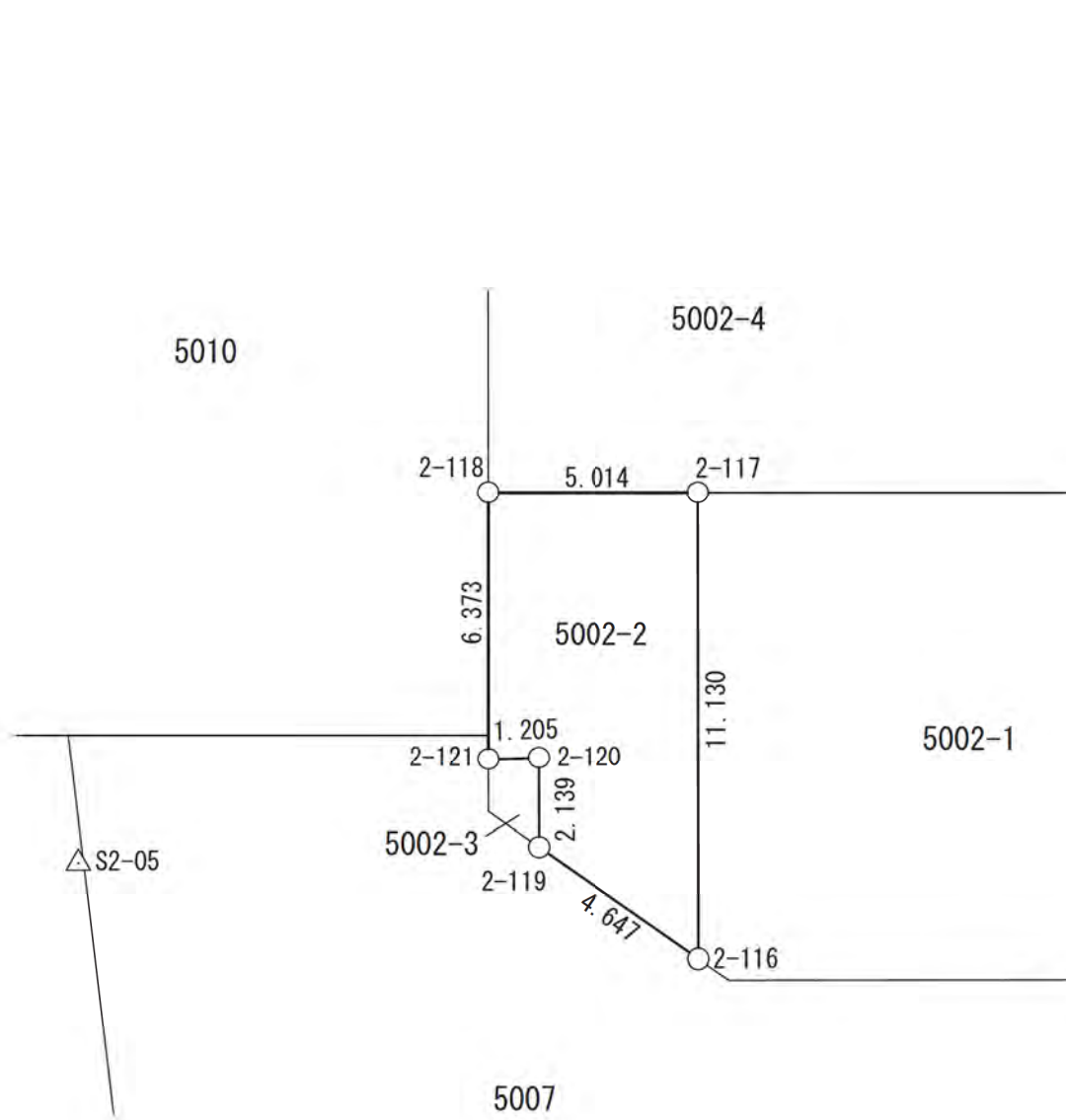

△ S2-0

基準点網図

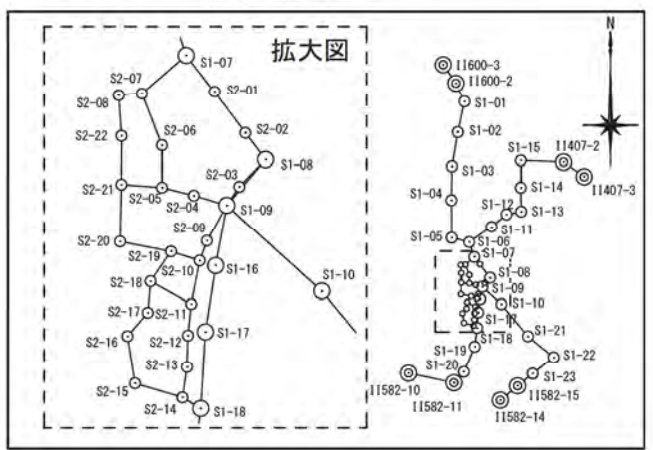

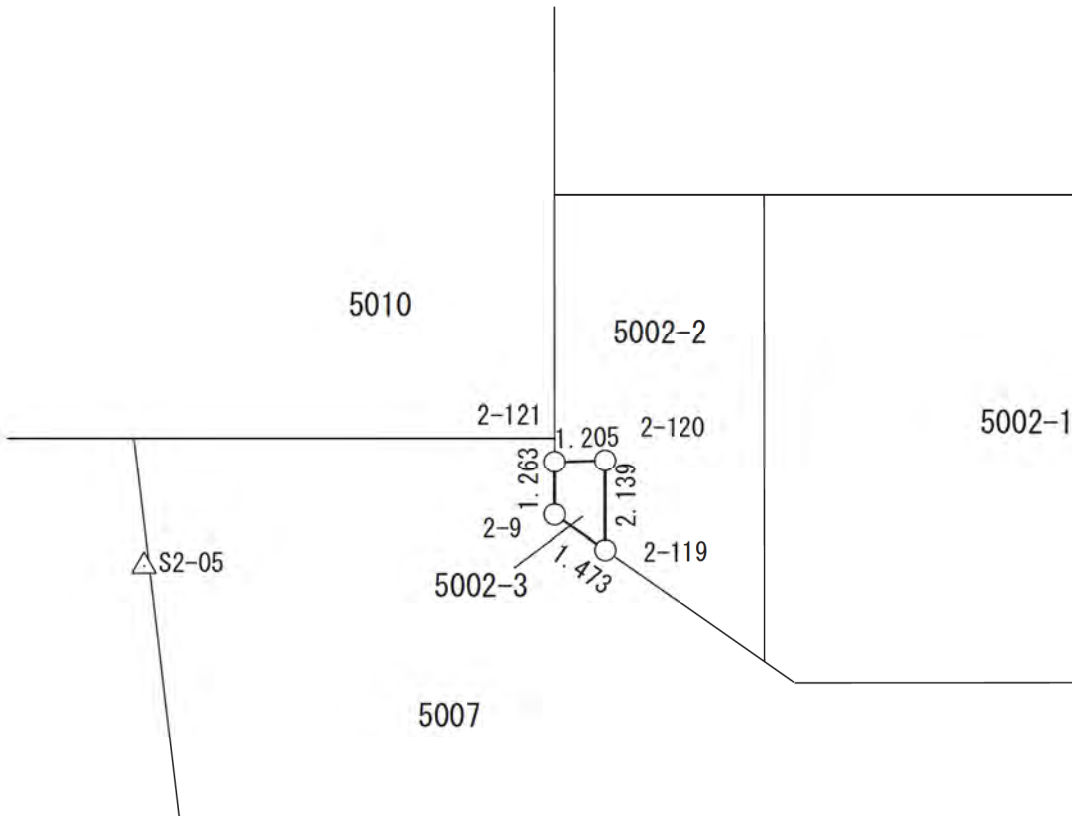

△ S2-0

基準点網図

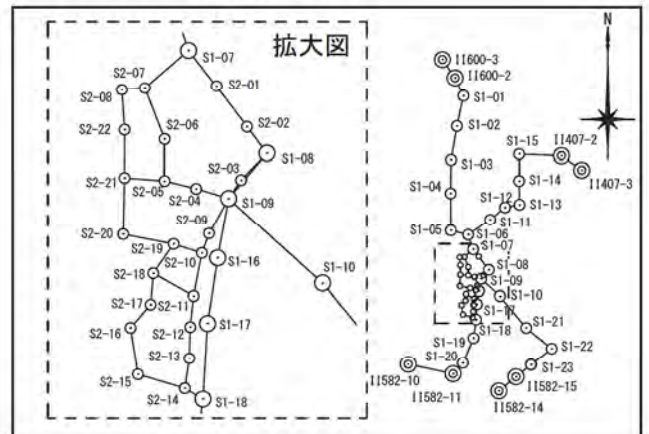

地 番

5002-4

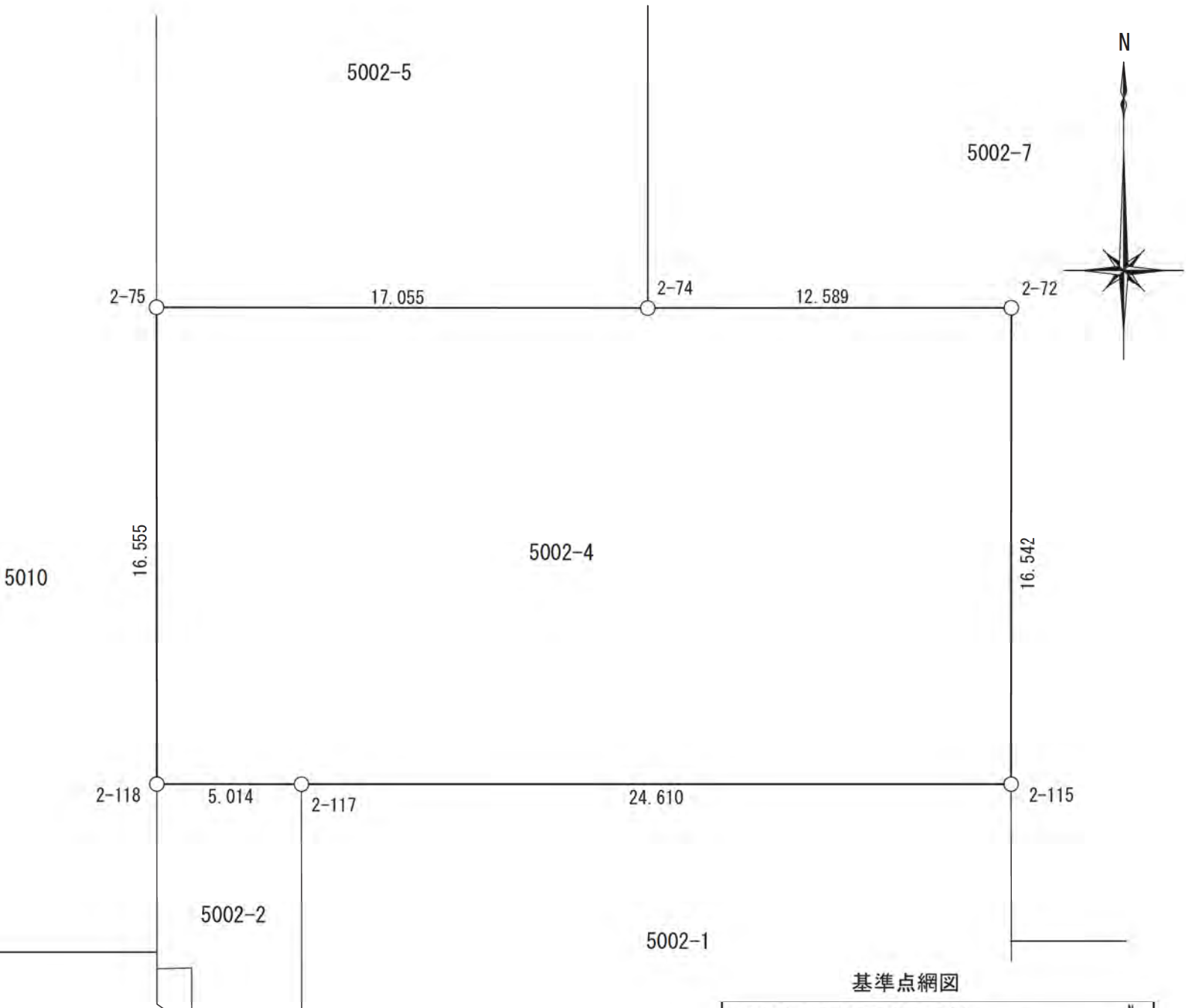

基準点網図

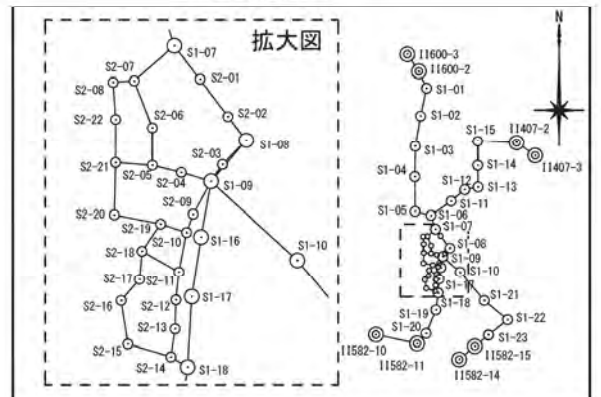

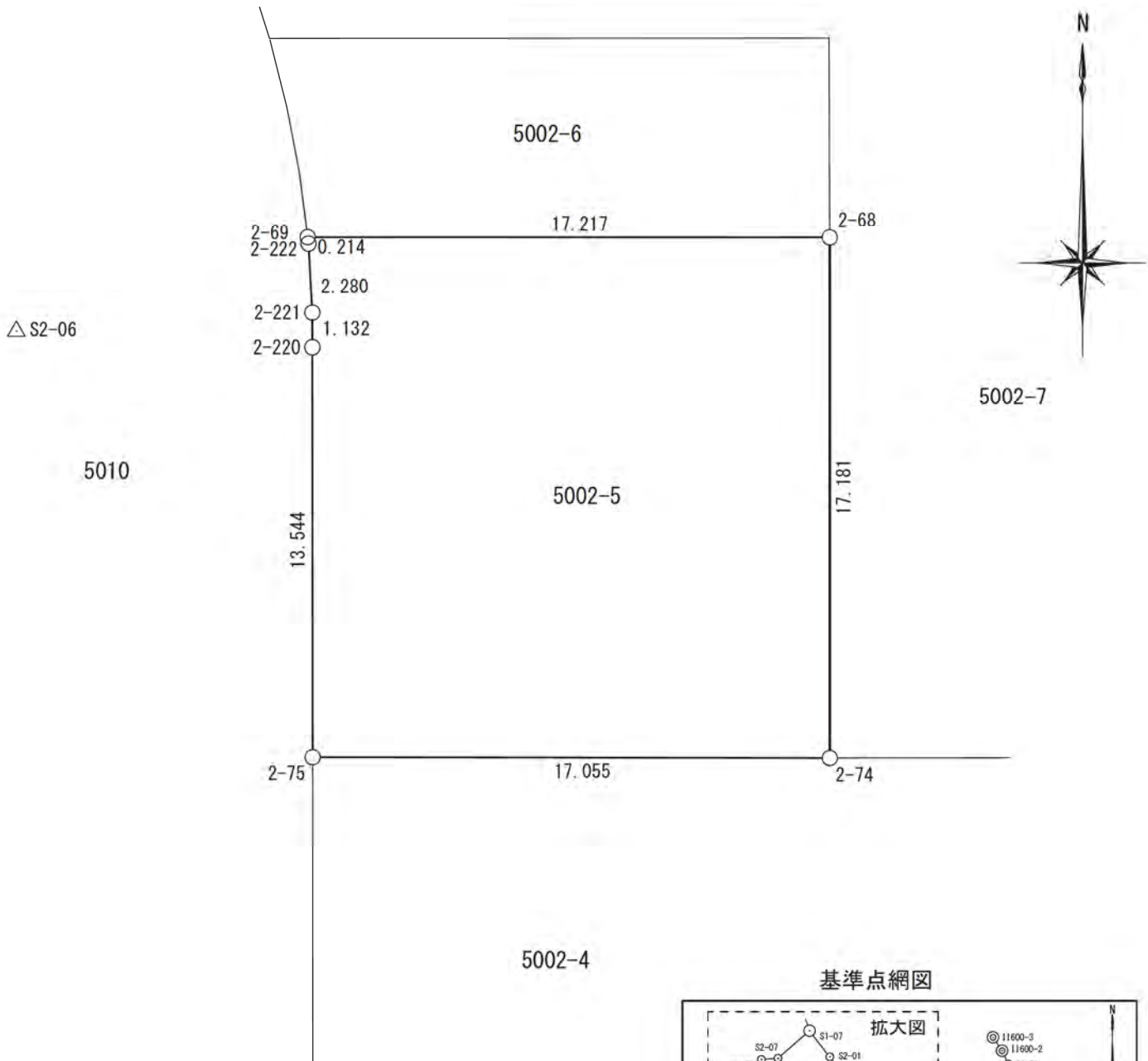

基準点網図

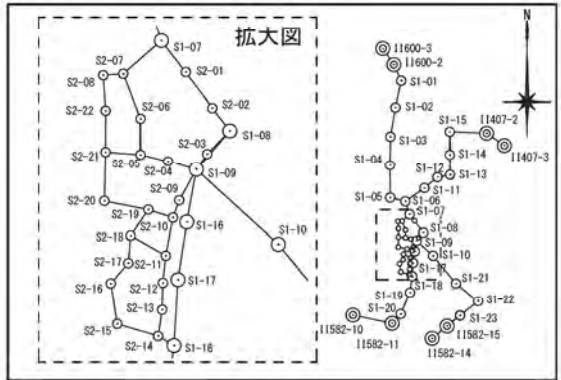

地 番 5002-6

拡大図

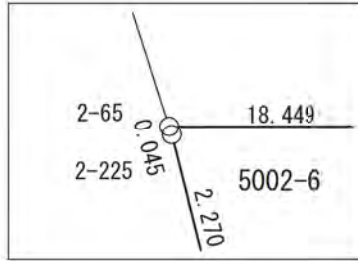

5002-7

5010

△ S2-06

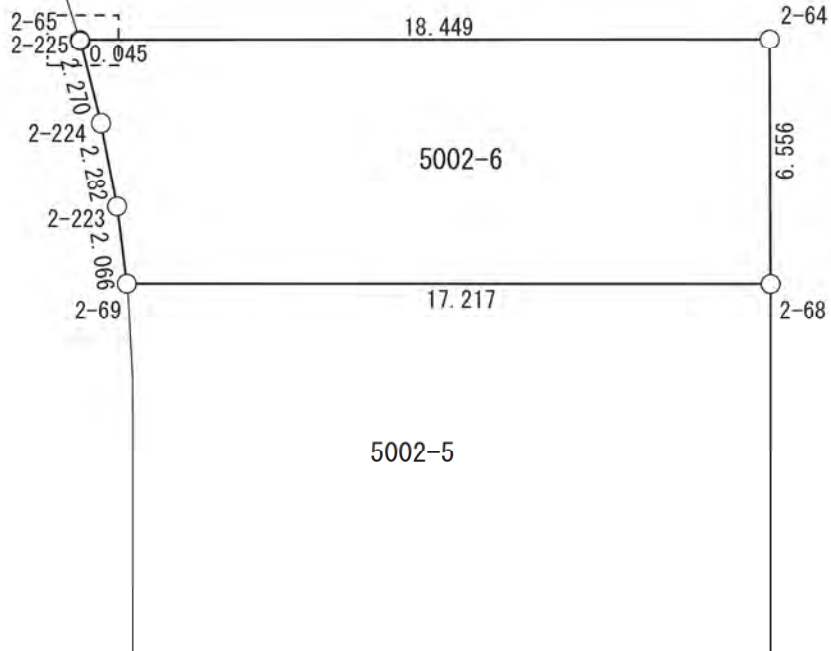

基準点網図

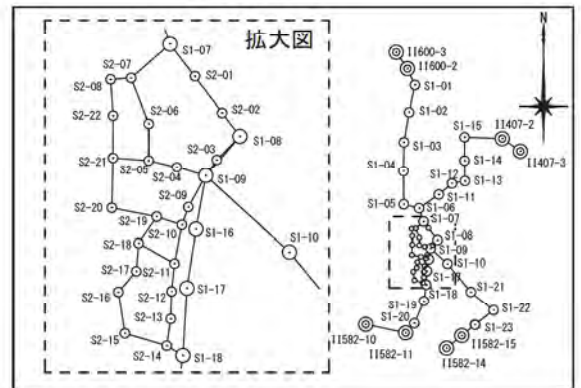

地番 5002-8



△S2-07

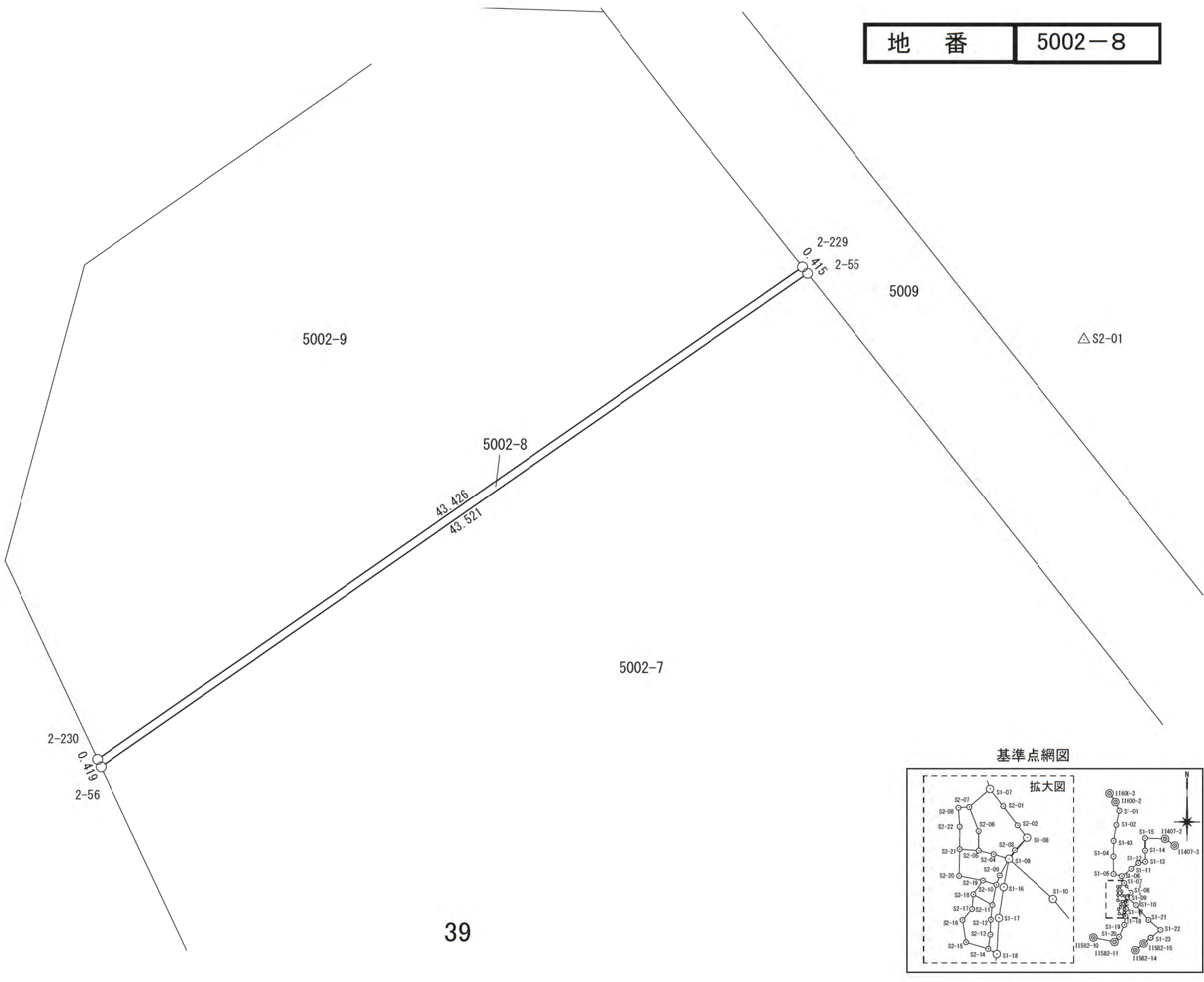

△S2-01

5002-9

5009

5002-8

5002-7

5010

2-230

2-56

2-229

2-55

43.426

43.521

0.415

0.416

基準点網図

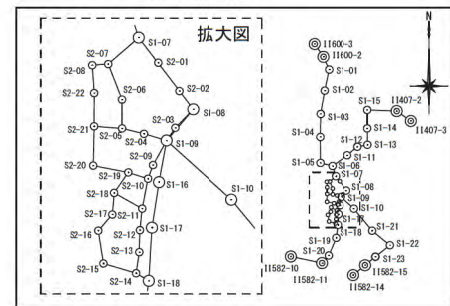

地 番 5002-9

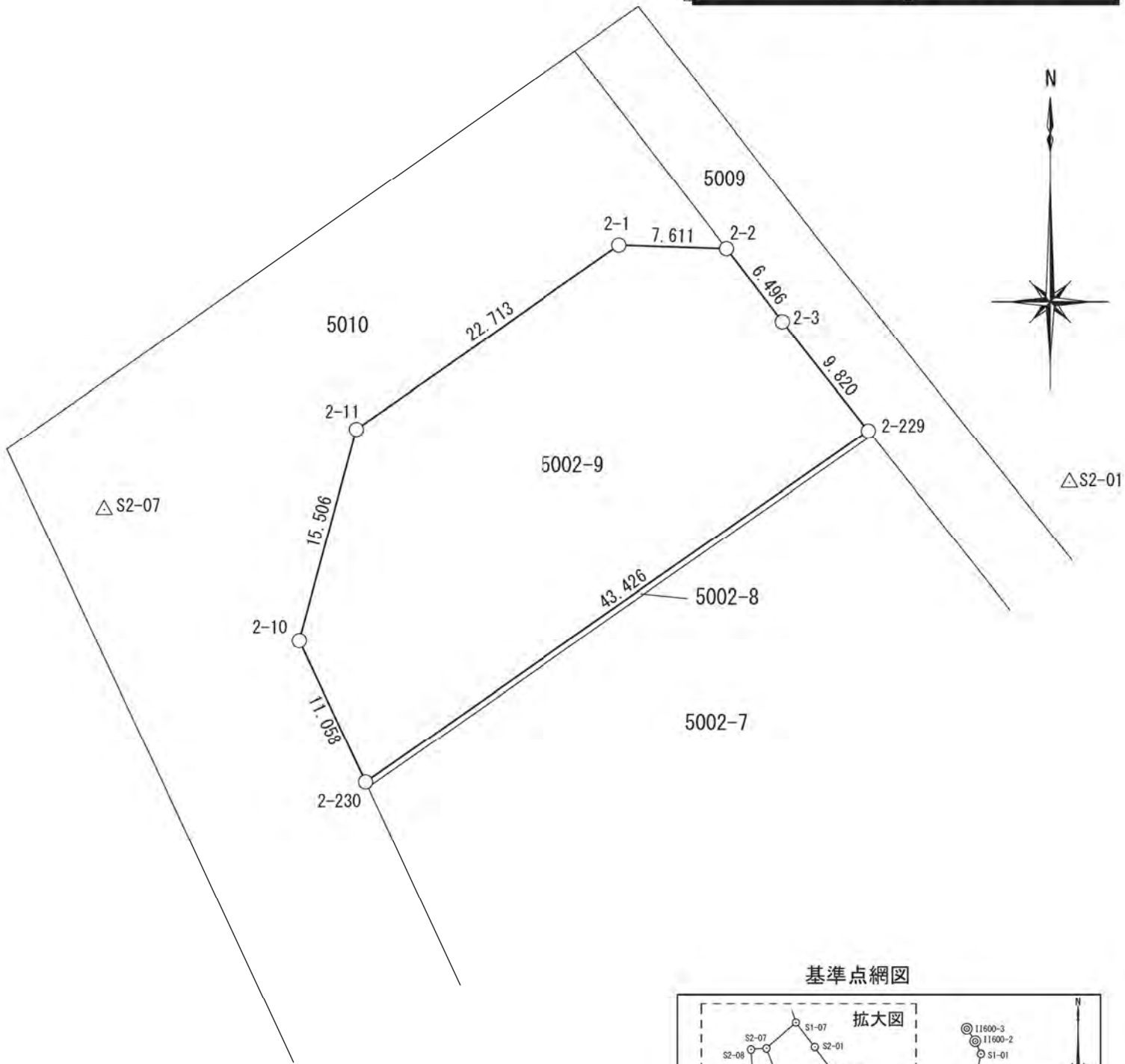

基準点網図

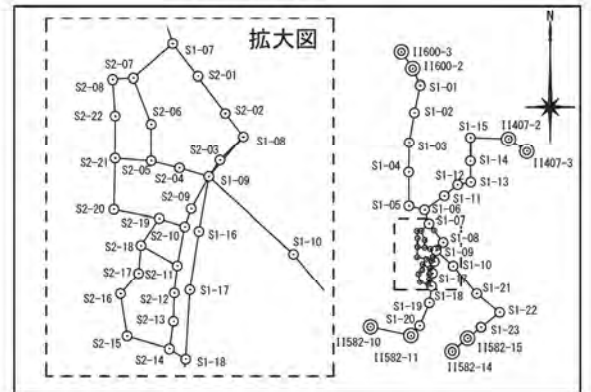

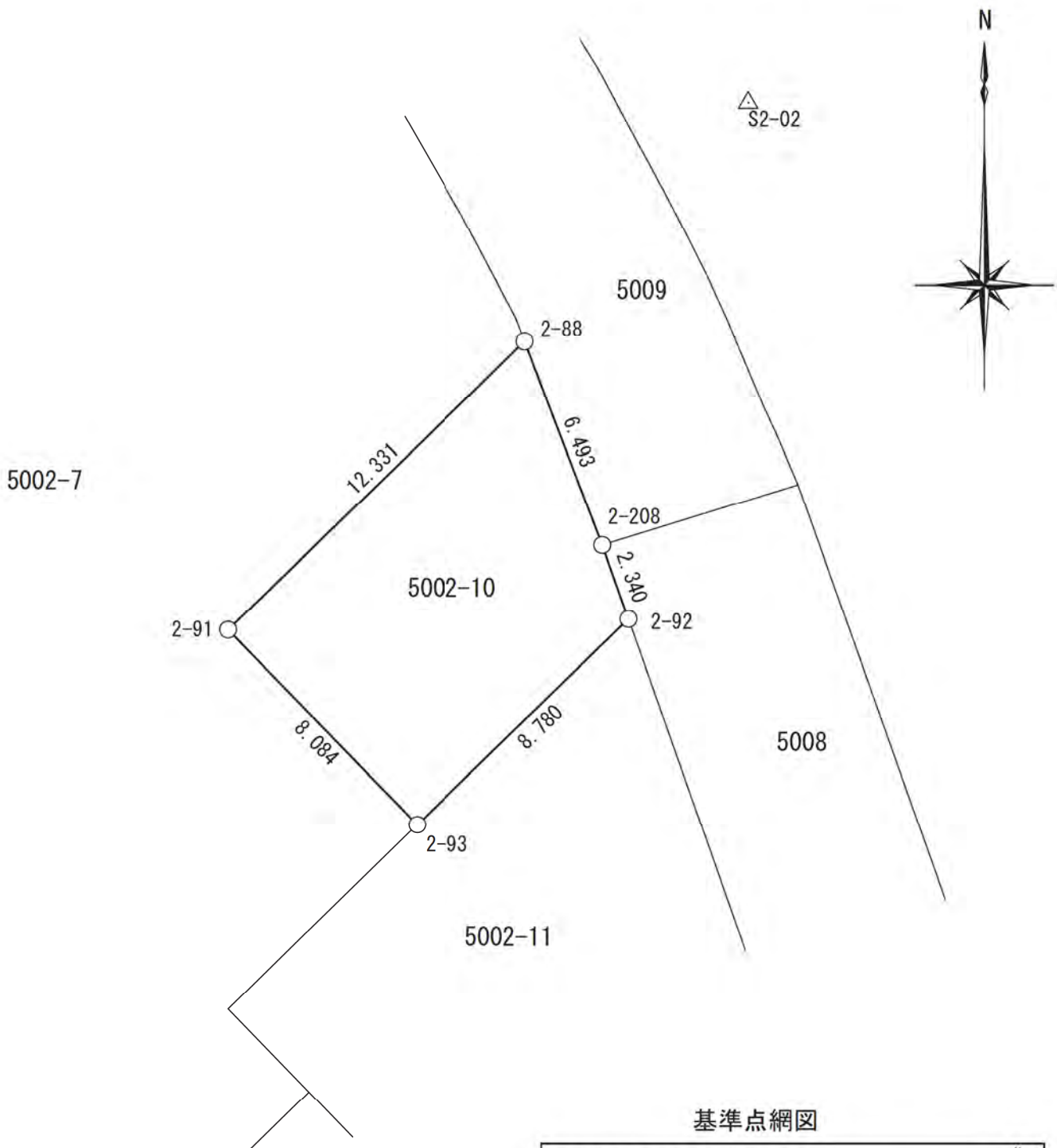

基準点網図

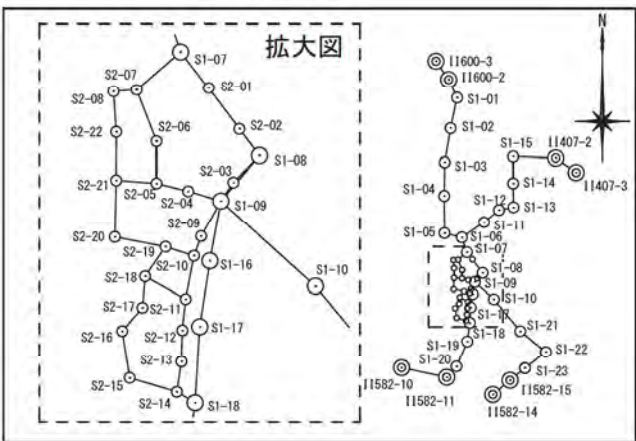

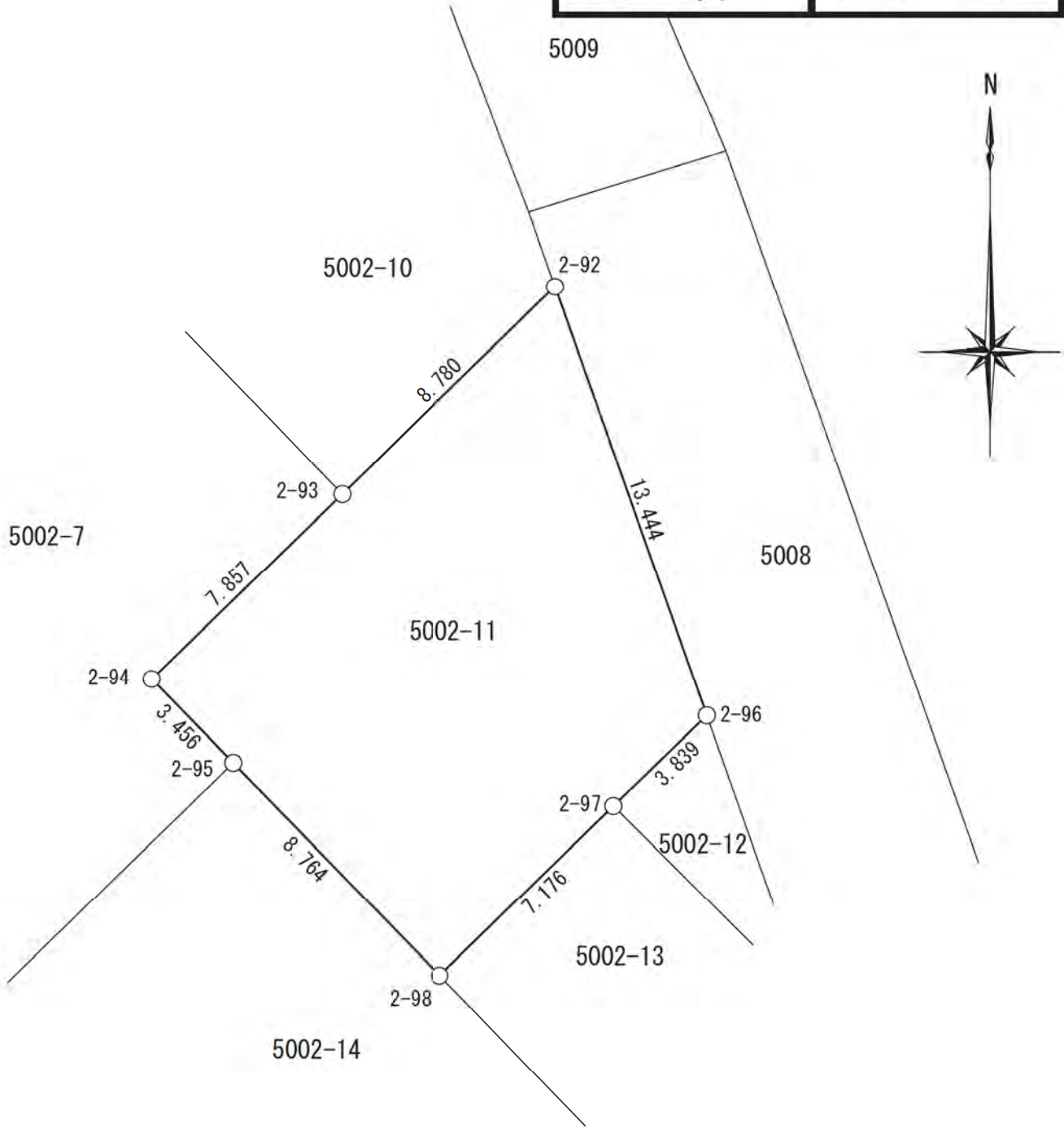

基準点網図

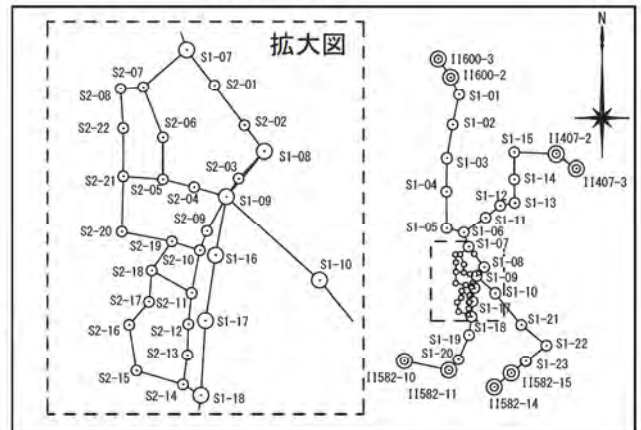

△ S2-03
42

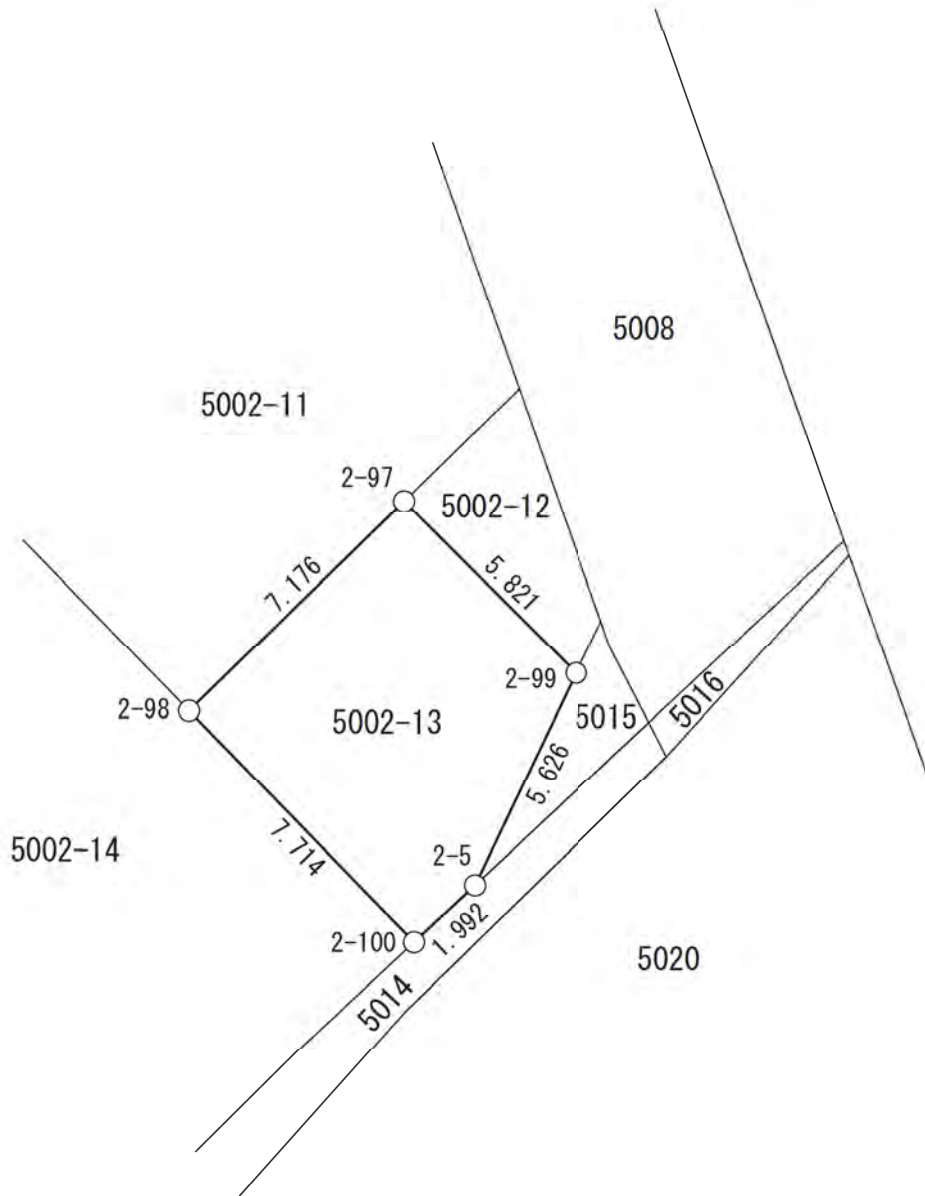

△ S1-08

△ S2-03

基準点網図

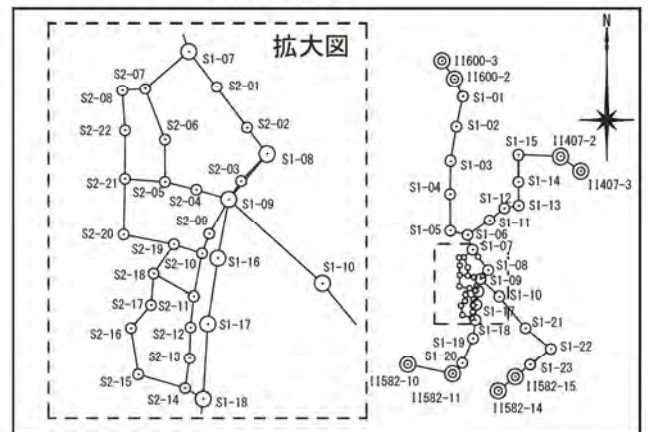

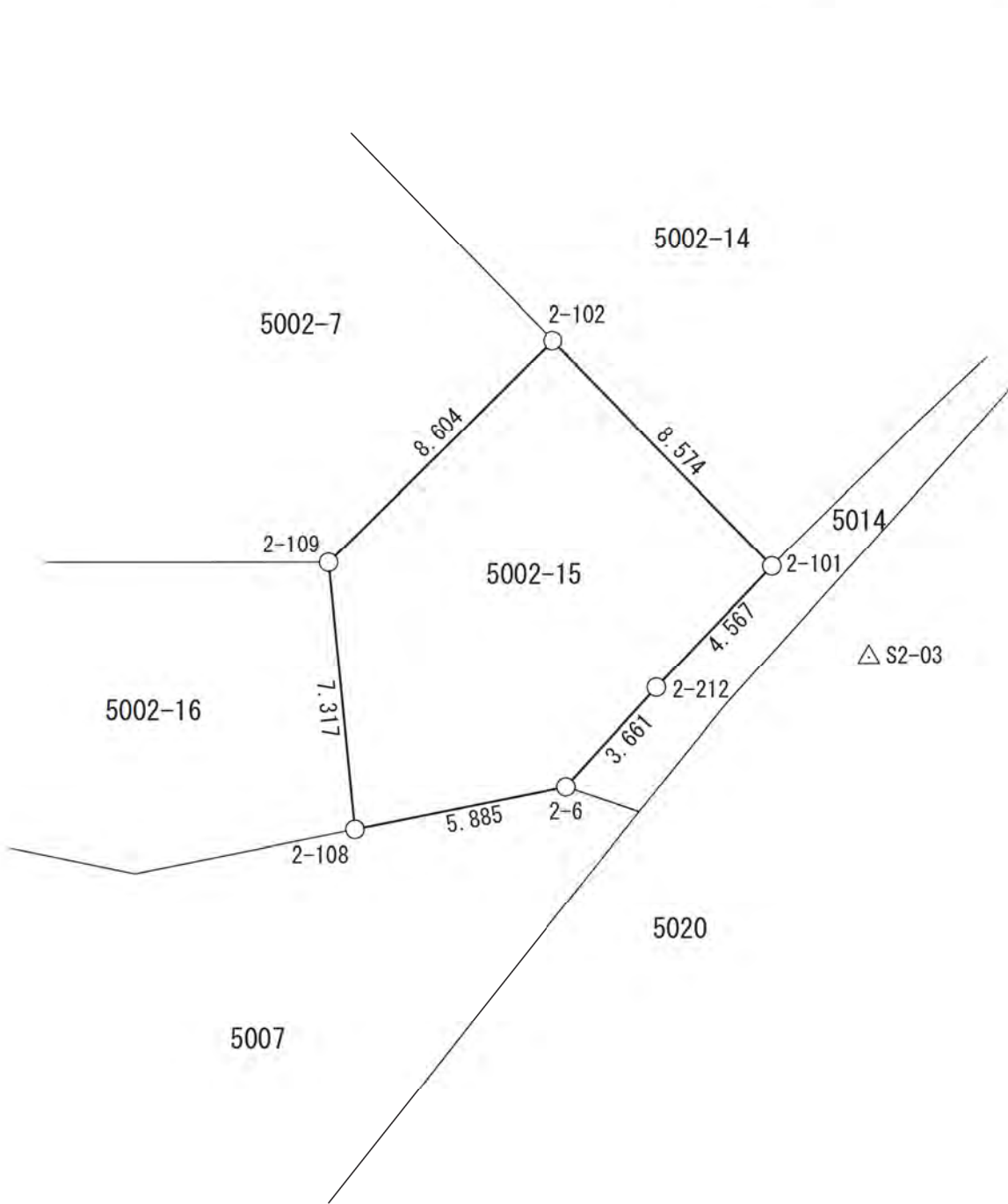

△S1-09

基準点網図

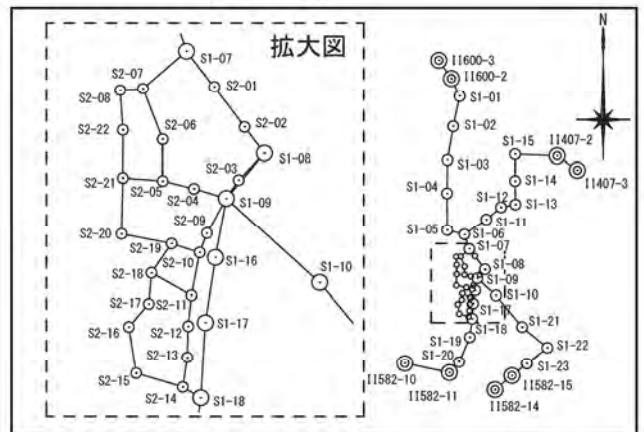

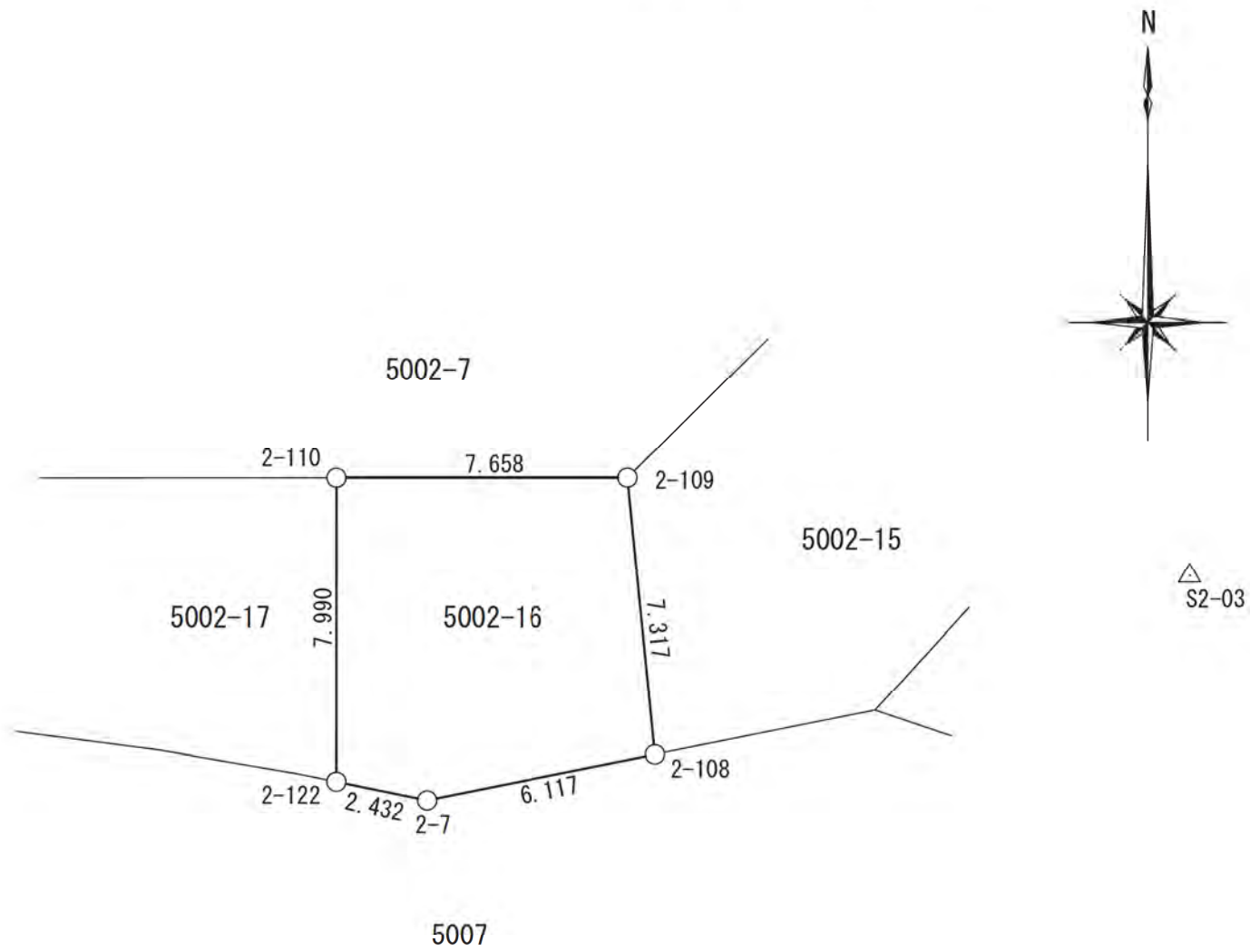

△ S1-09

基準点網図

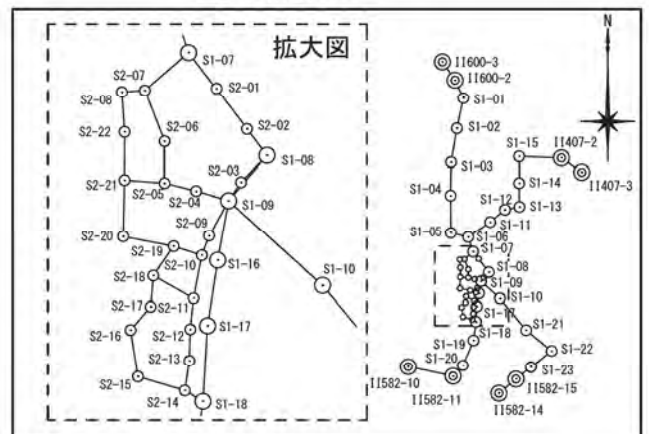

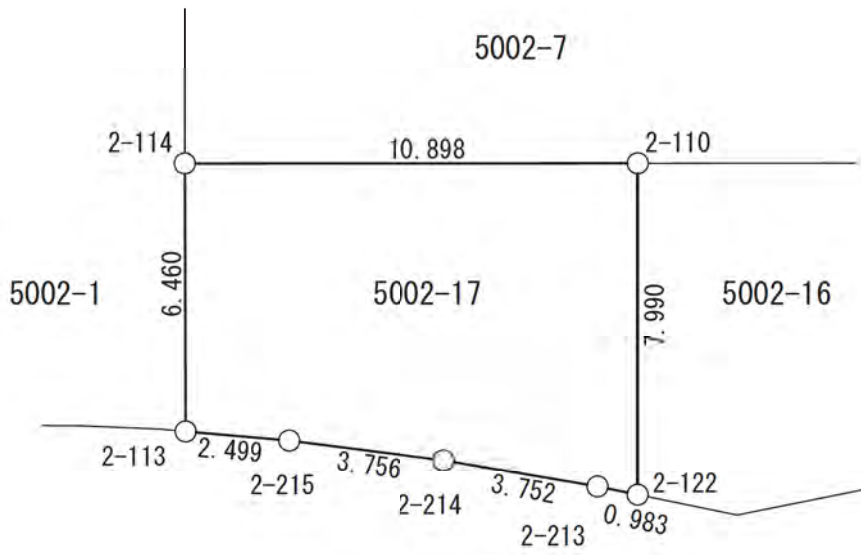

△S2-04

5007

基準点網図

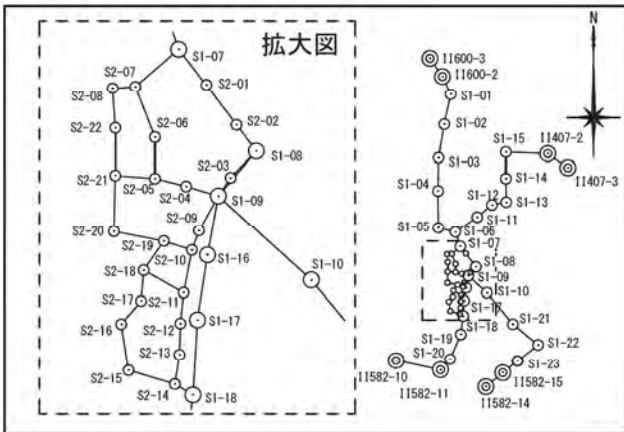

△S1-09

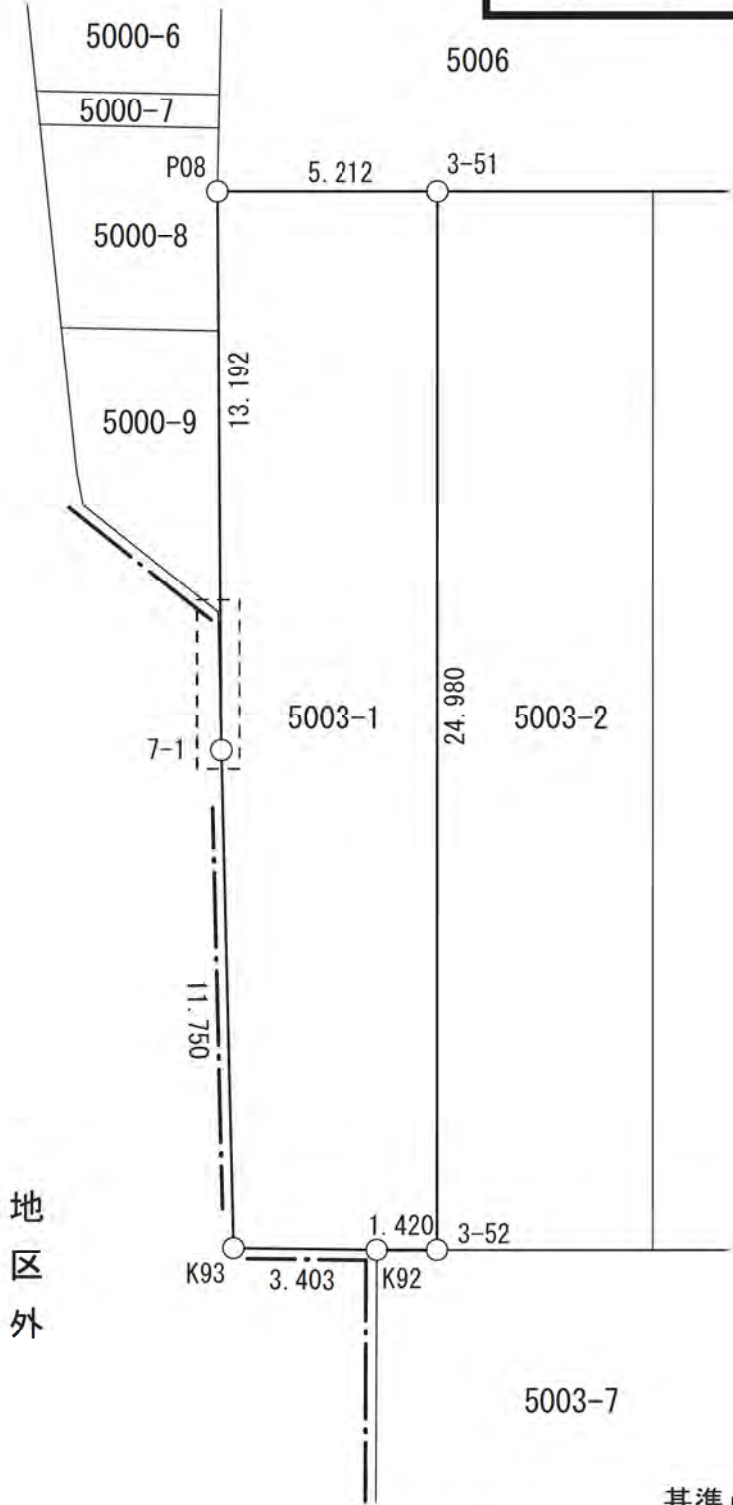
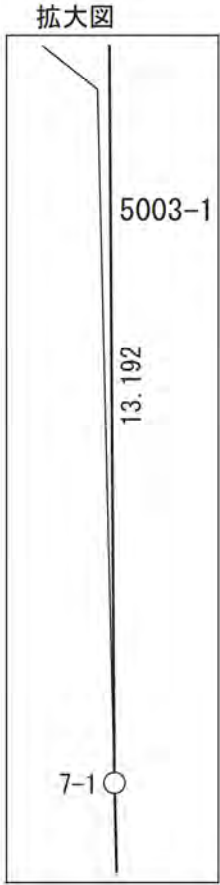

地区外

基準点網図

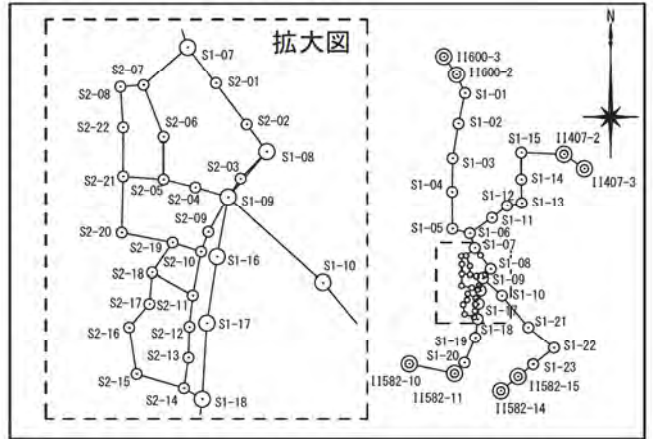

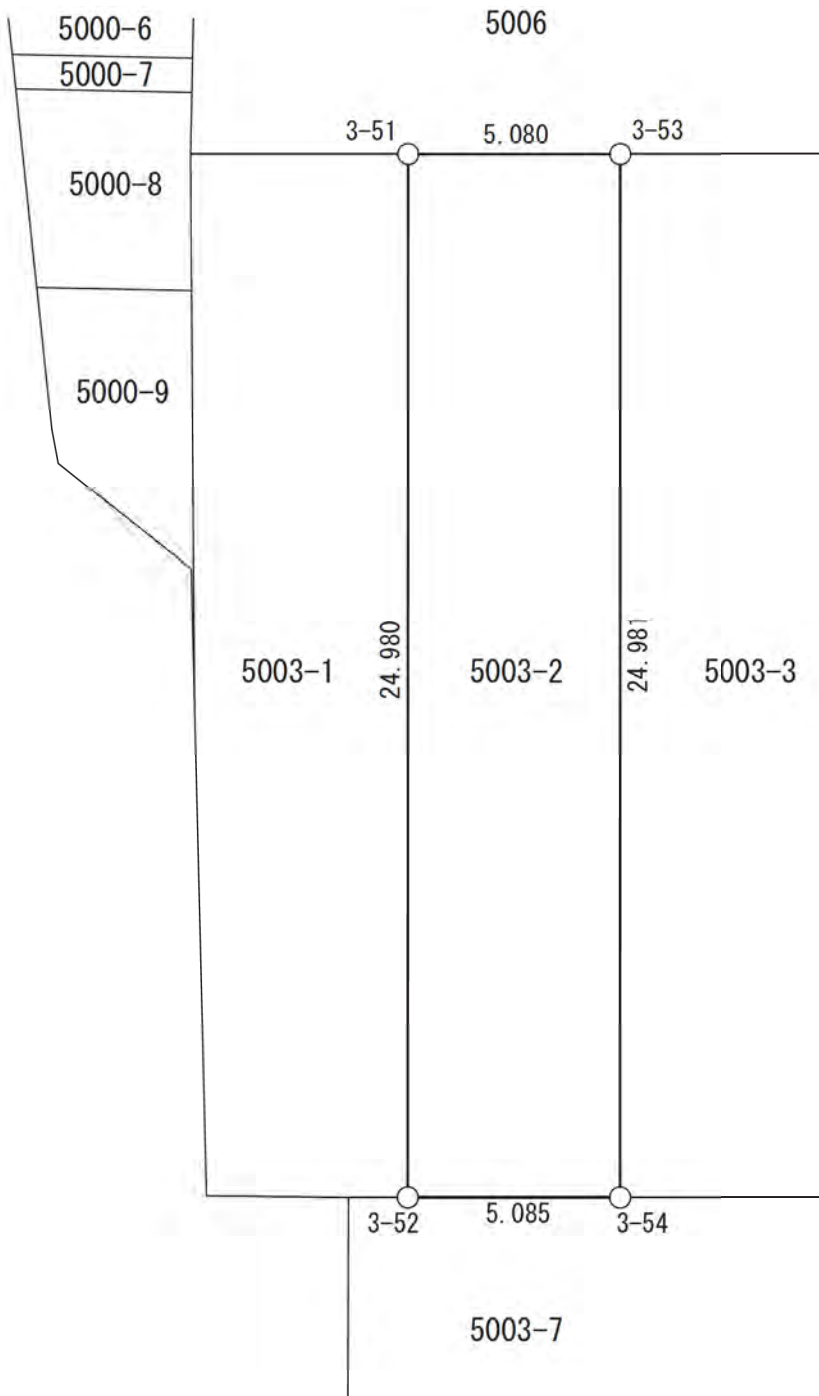

△ S2-18

基準点網図

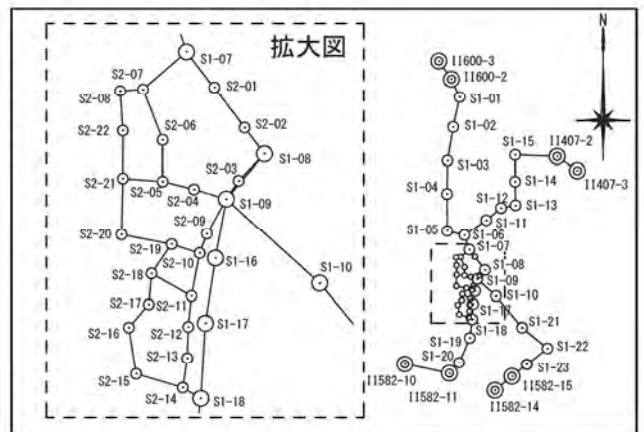

5006

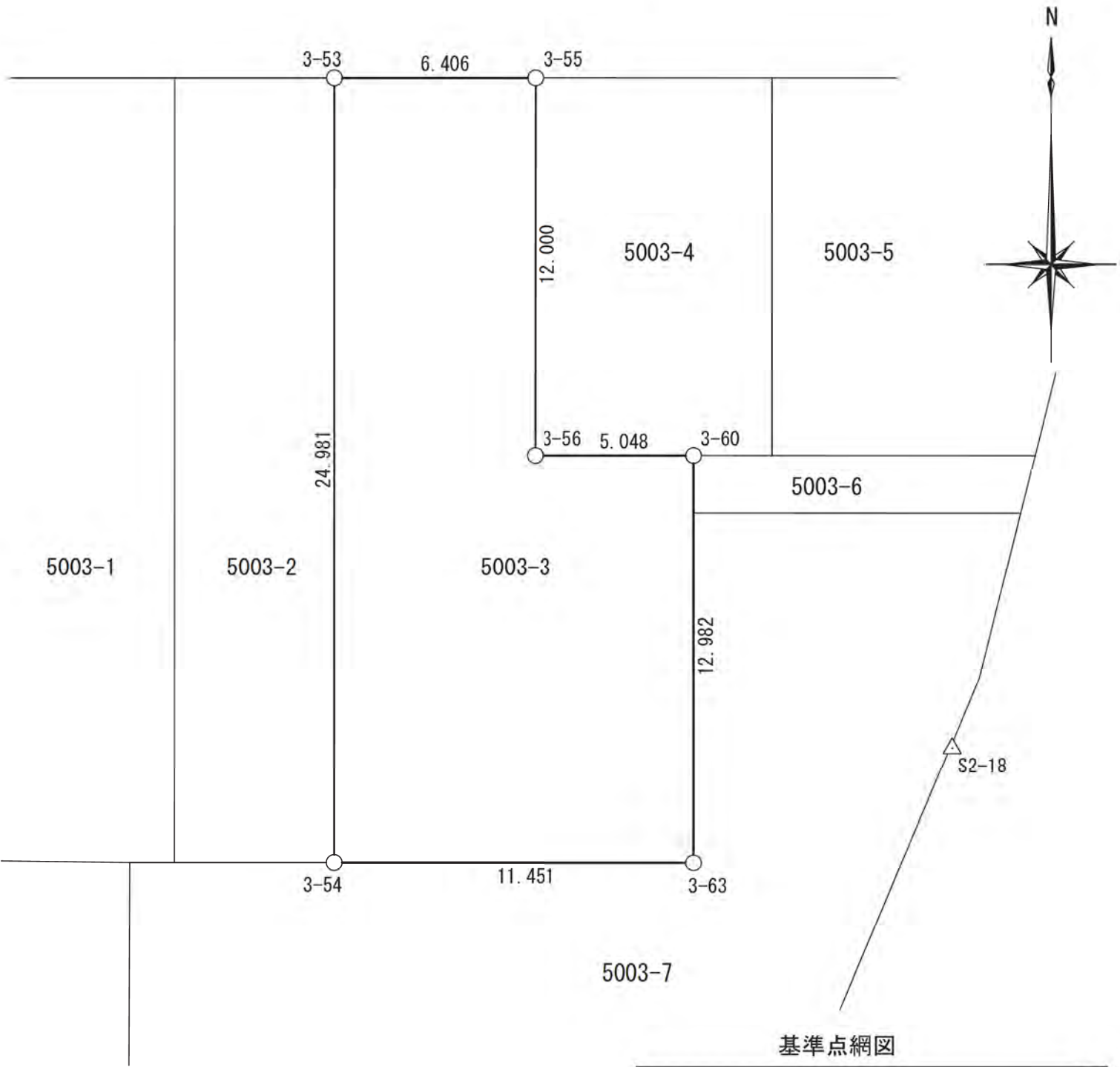

基準点網図

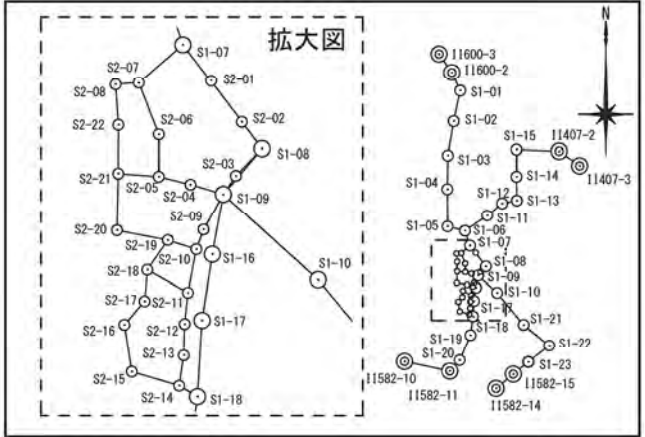

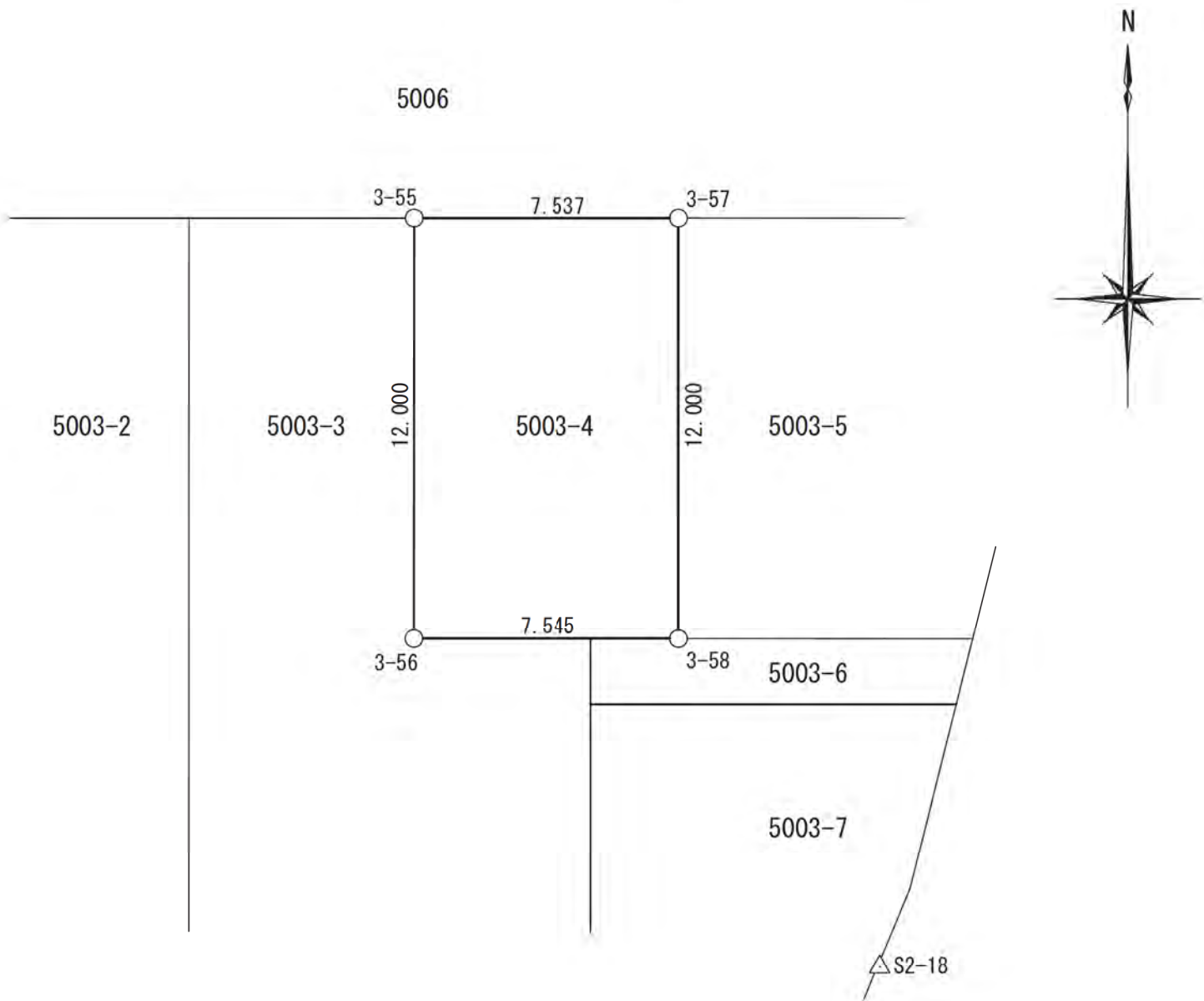

基準点網図

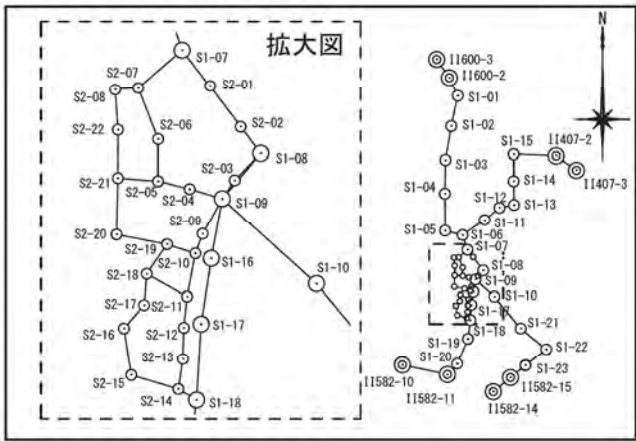

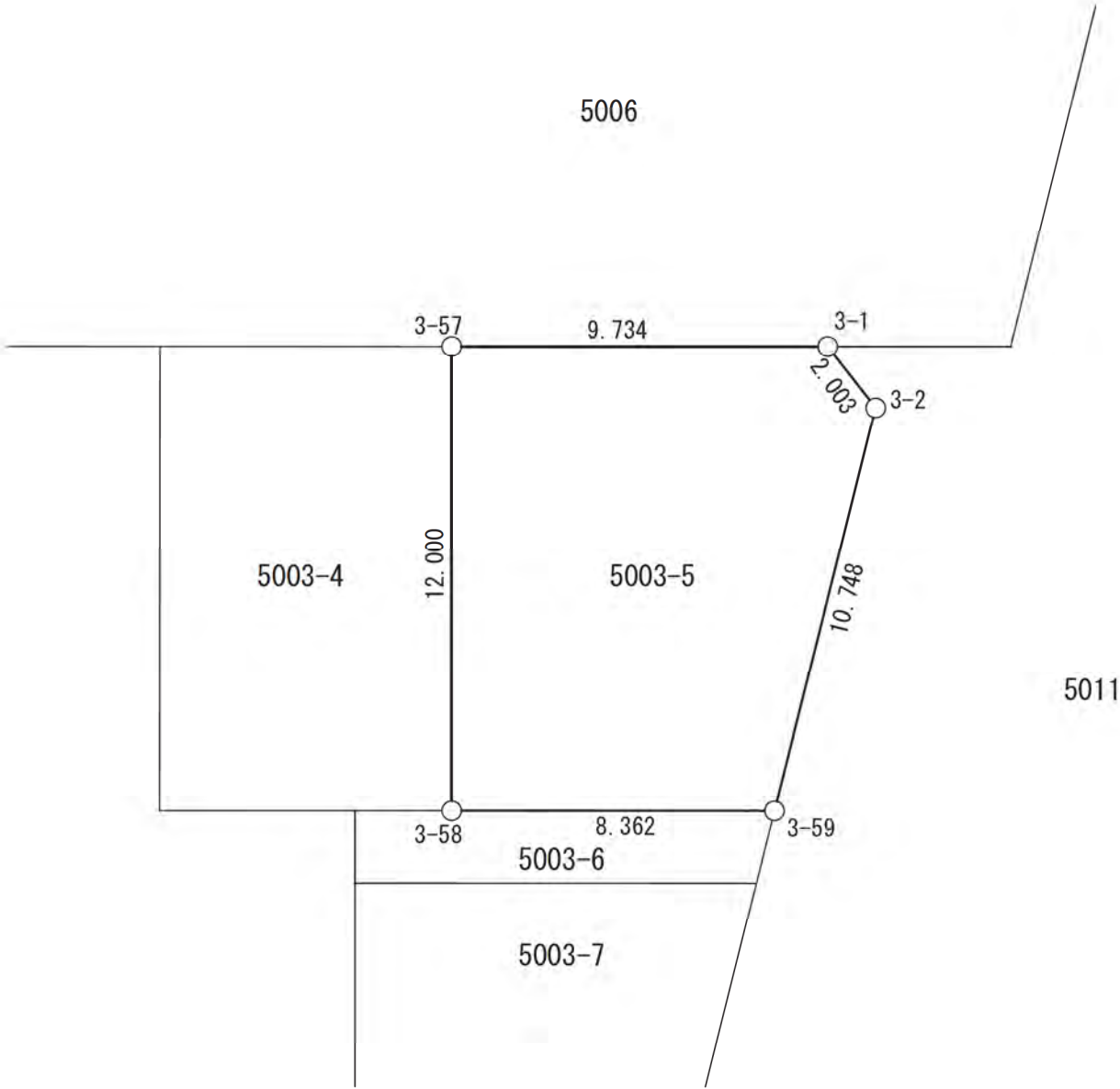

△S2-18

基準点網図

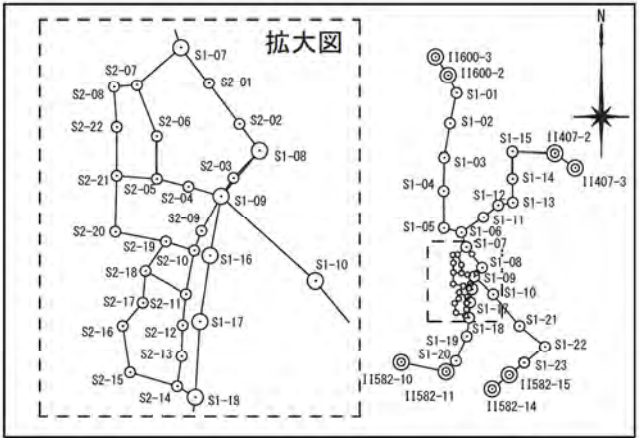

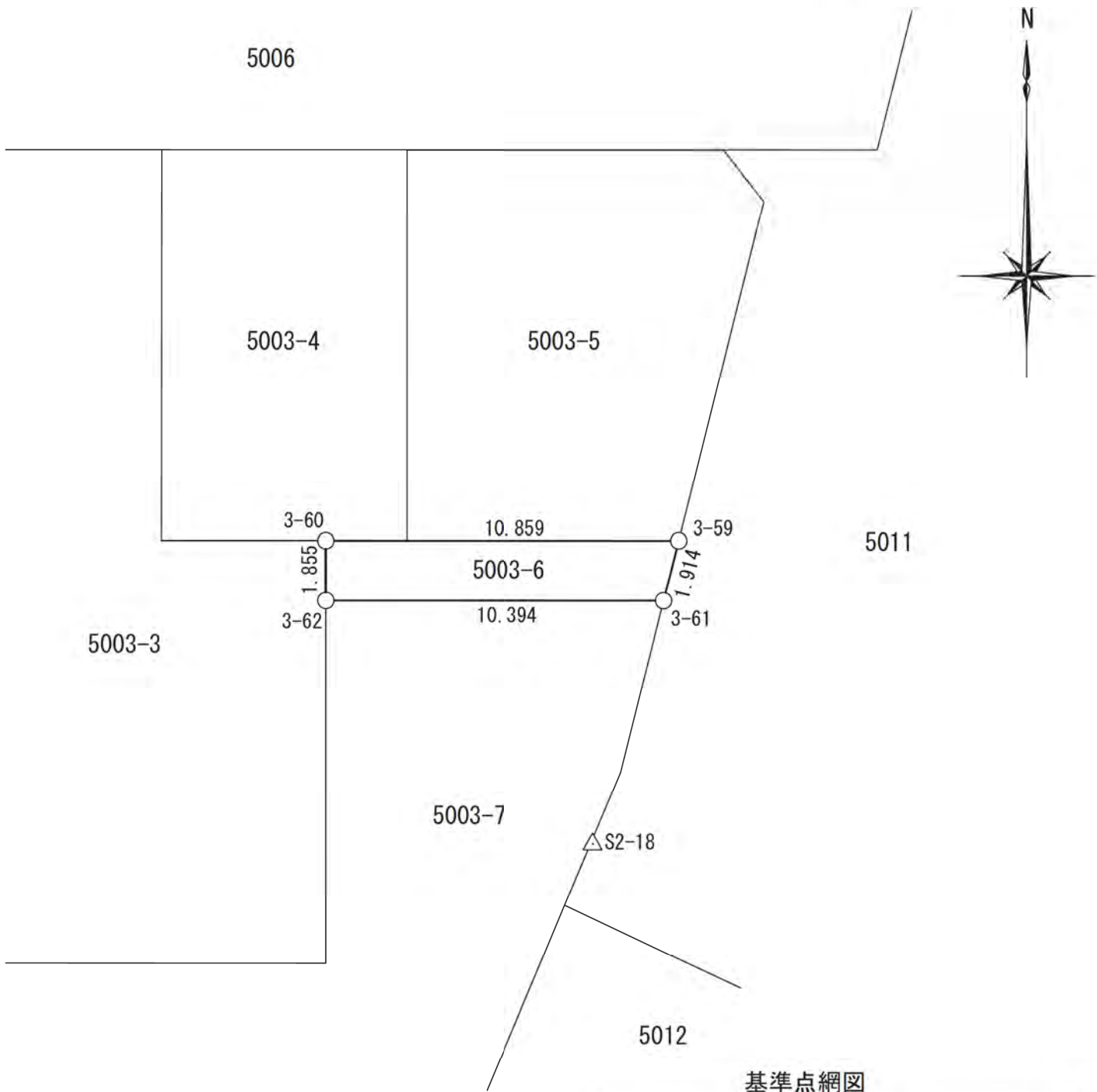

基準点網図

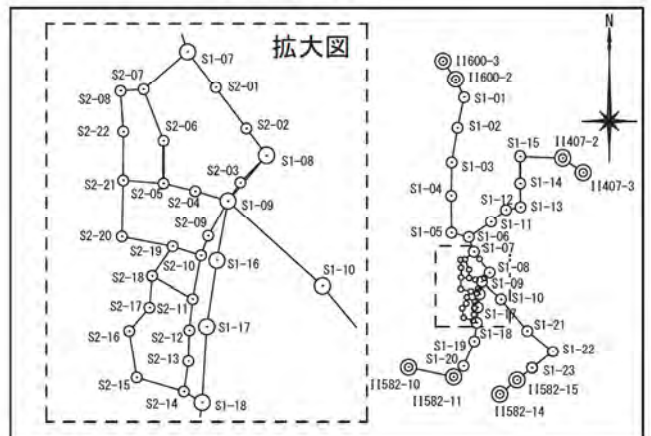

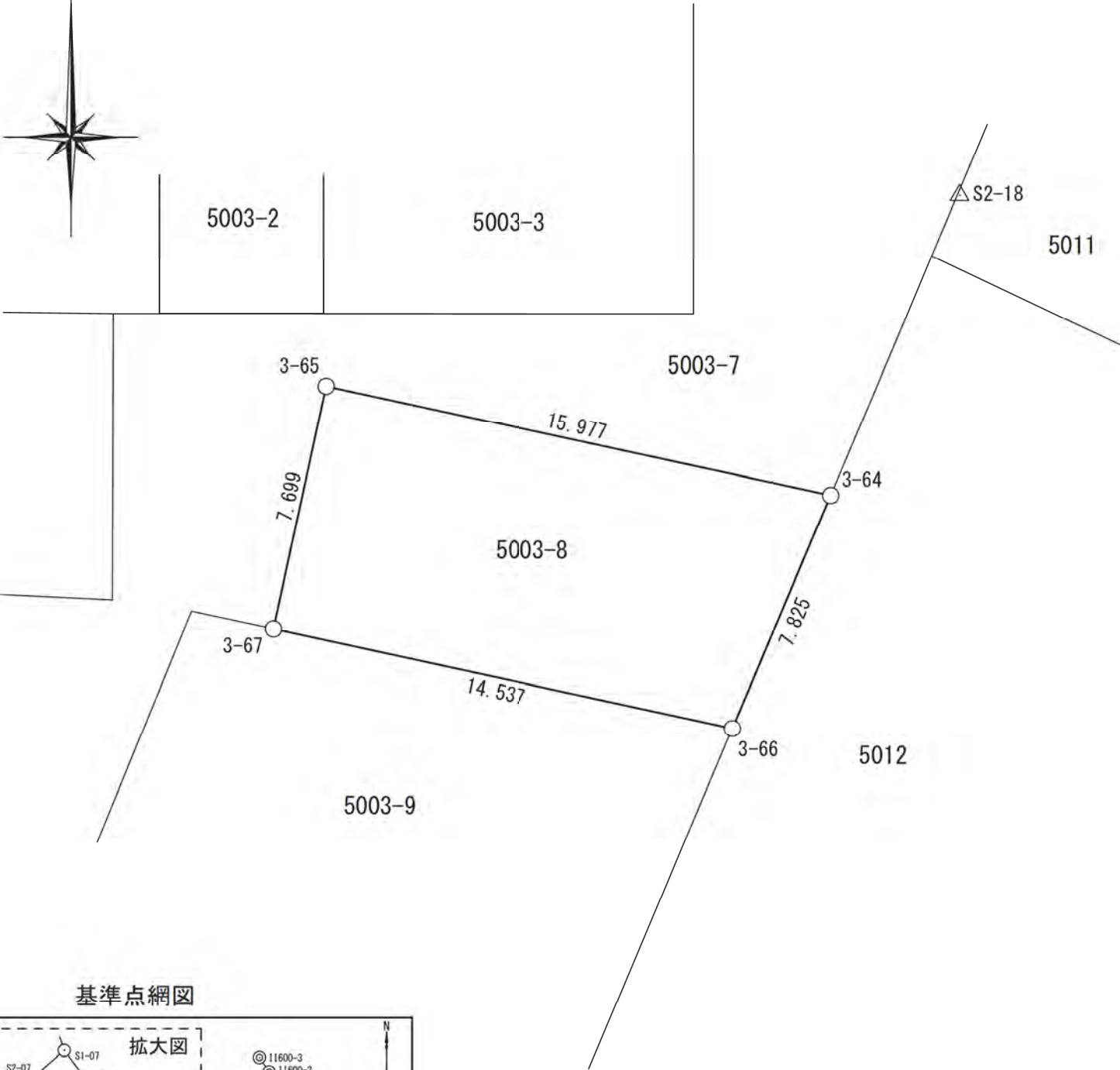

基準点網図

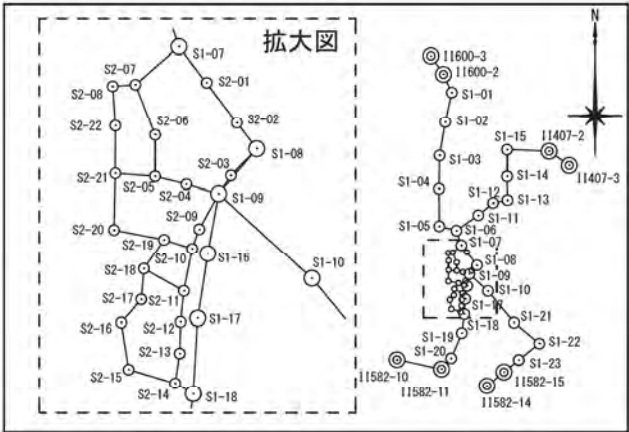

△ S2-17

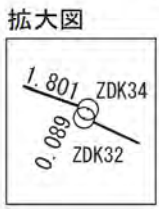
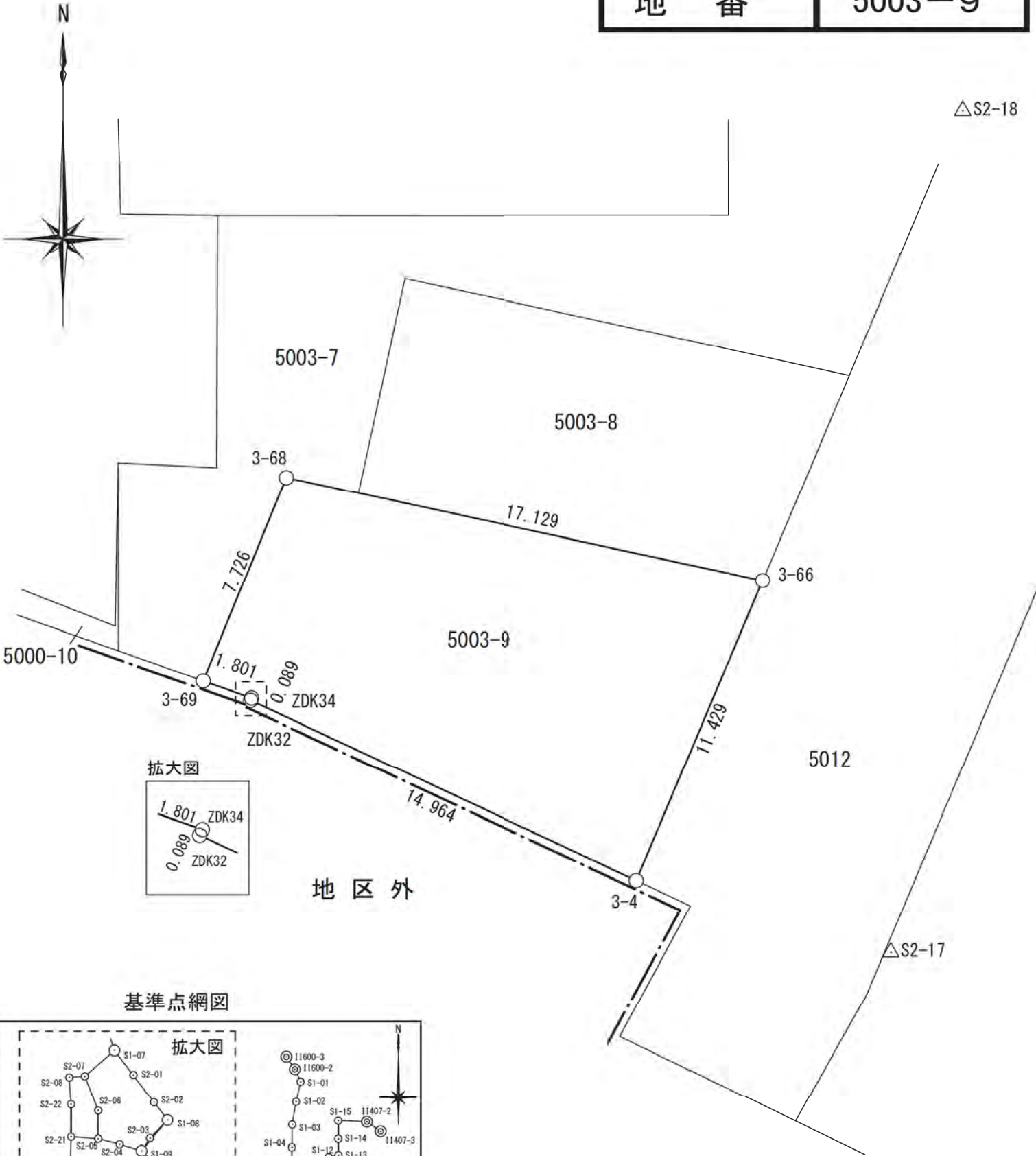

地区外

基準点網図

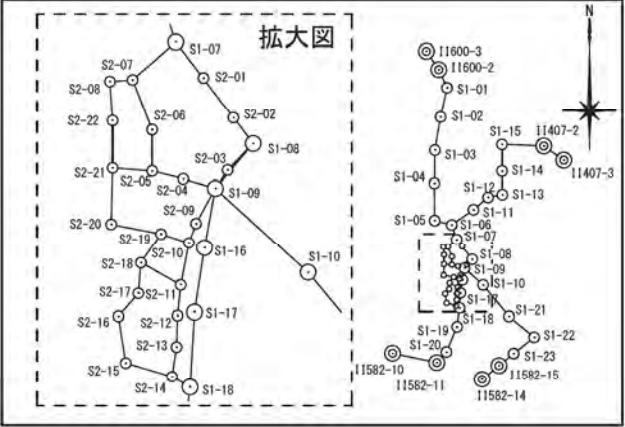

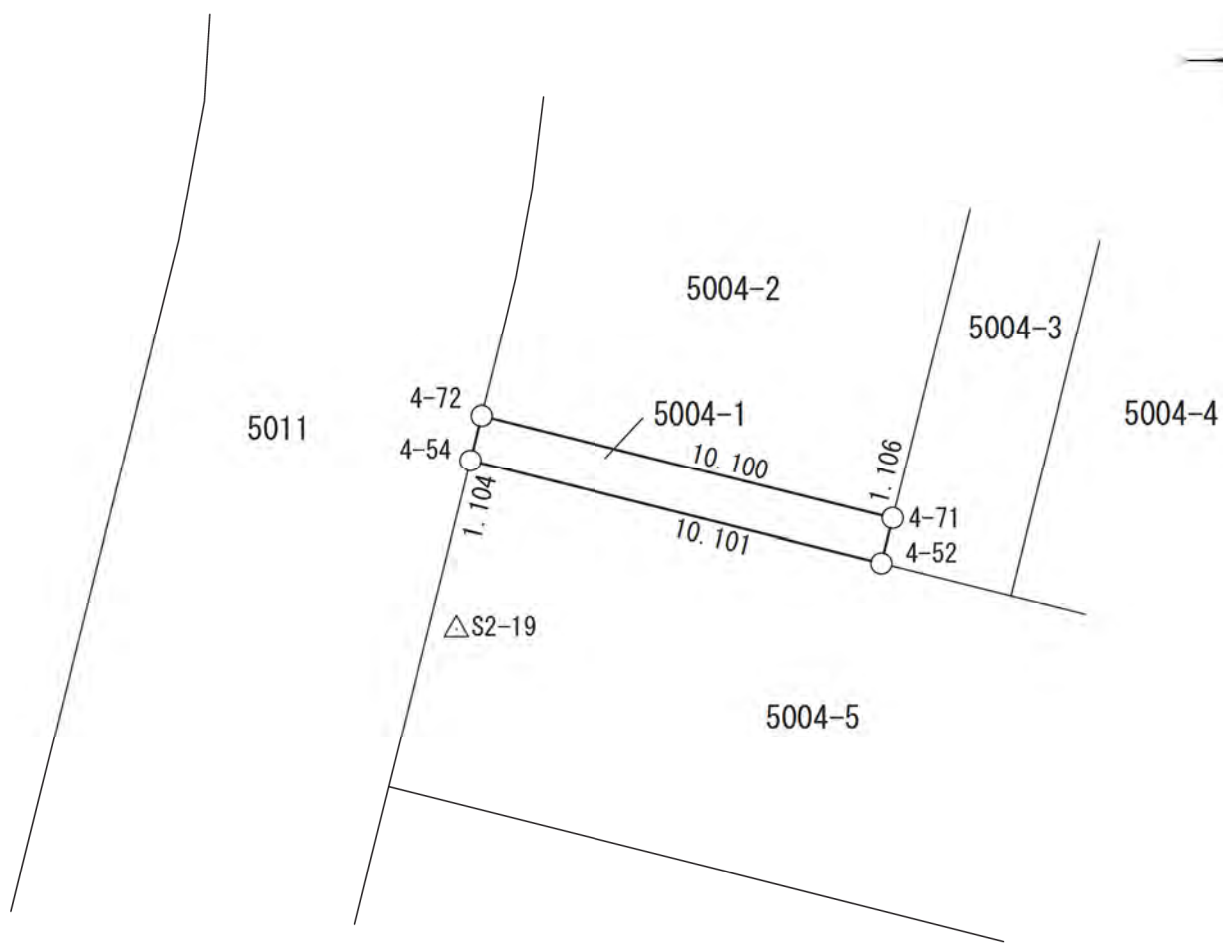

基準点網図

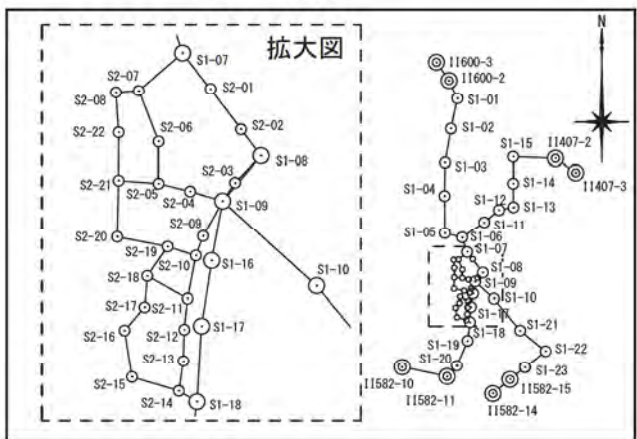

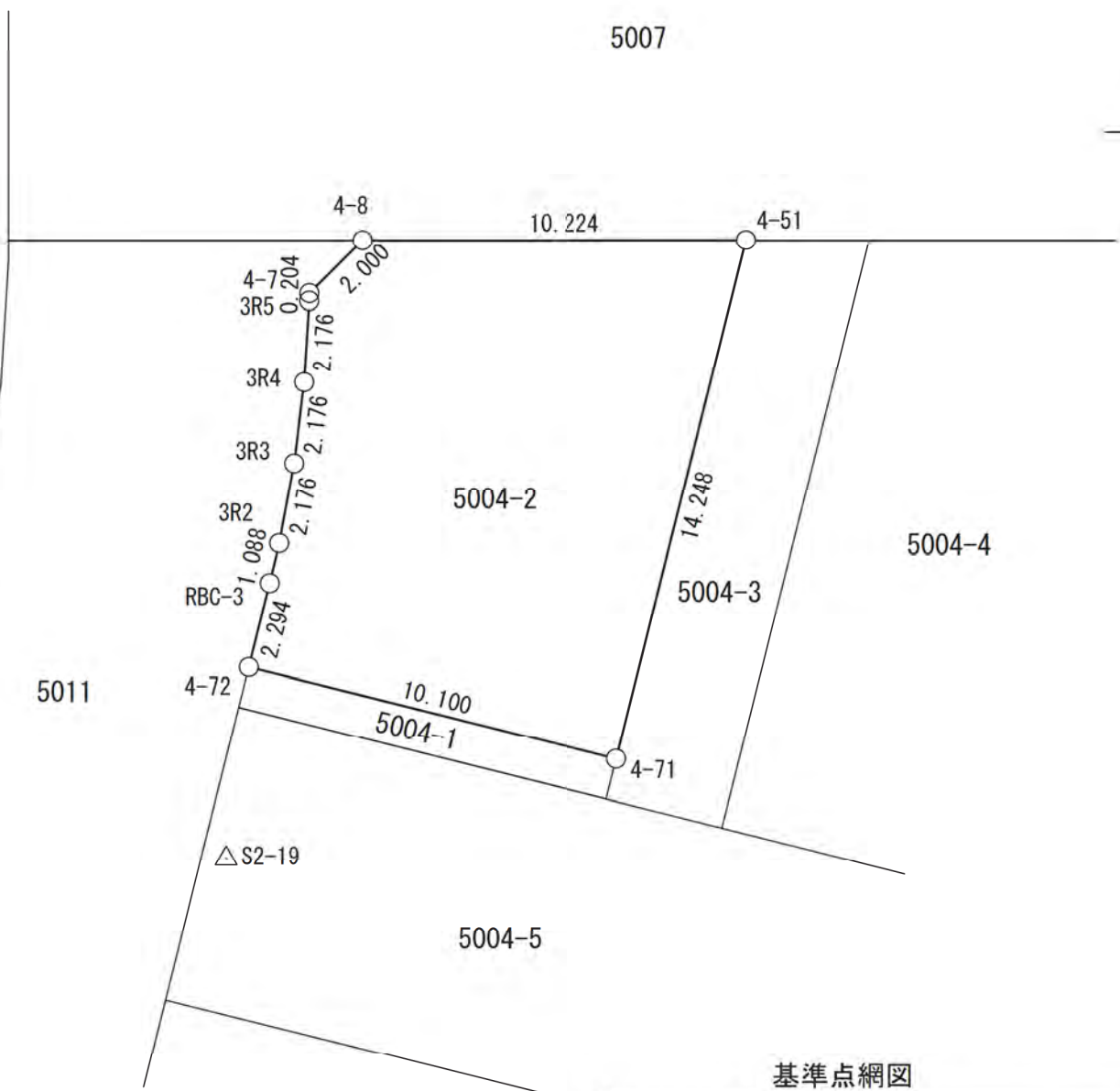

基準点網図

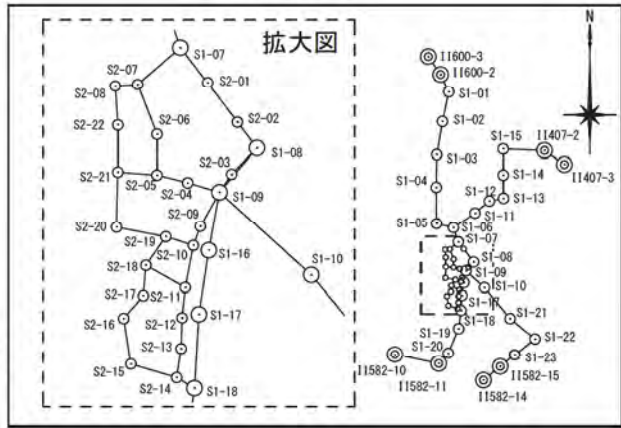

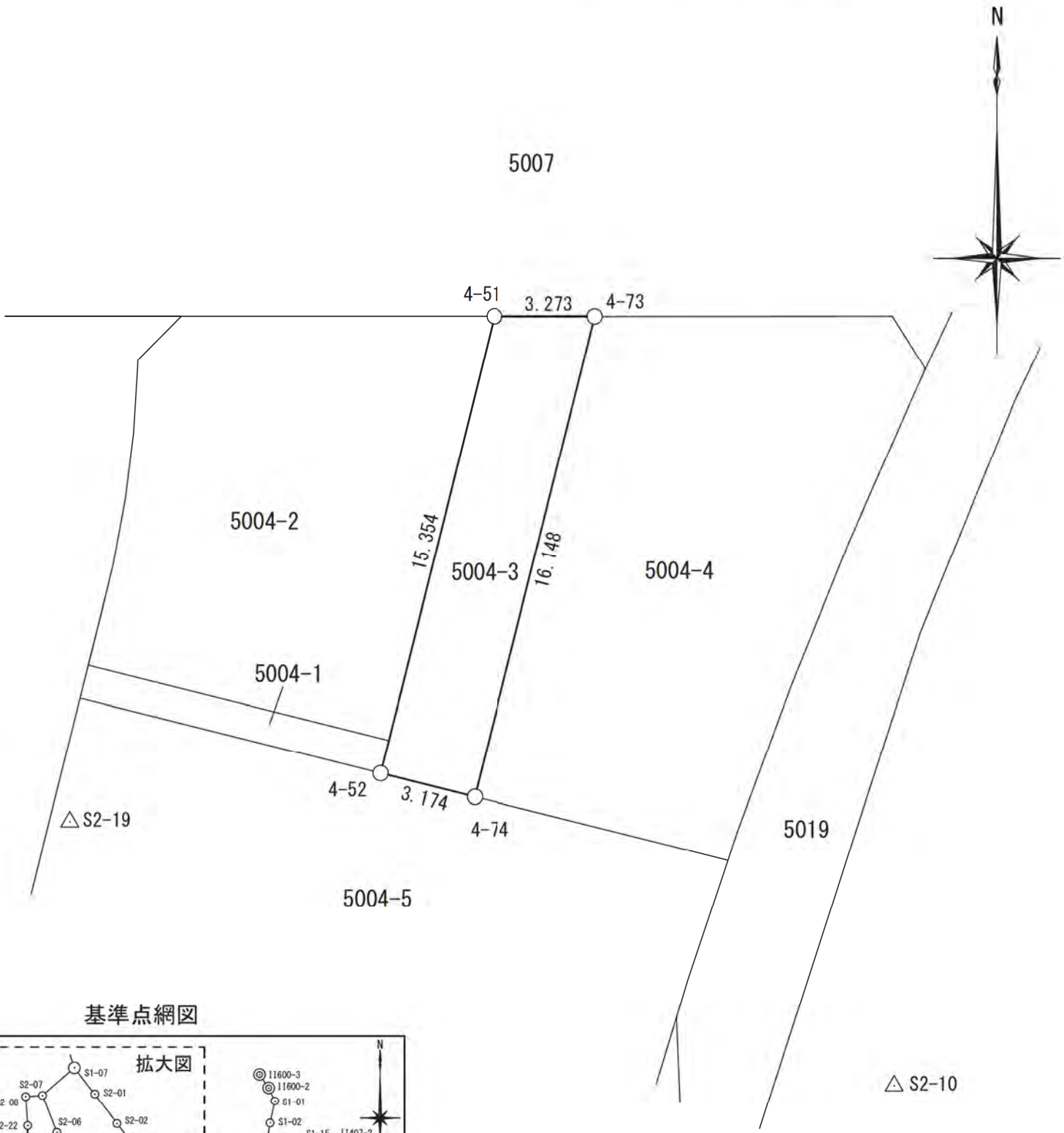

基準点網図

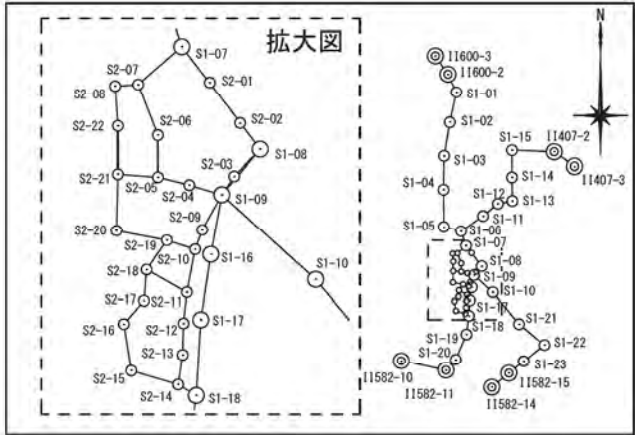

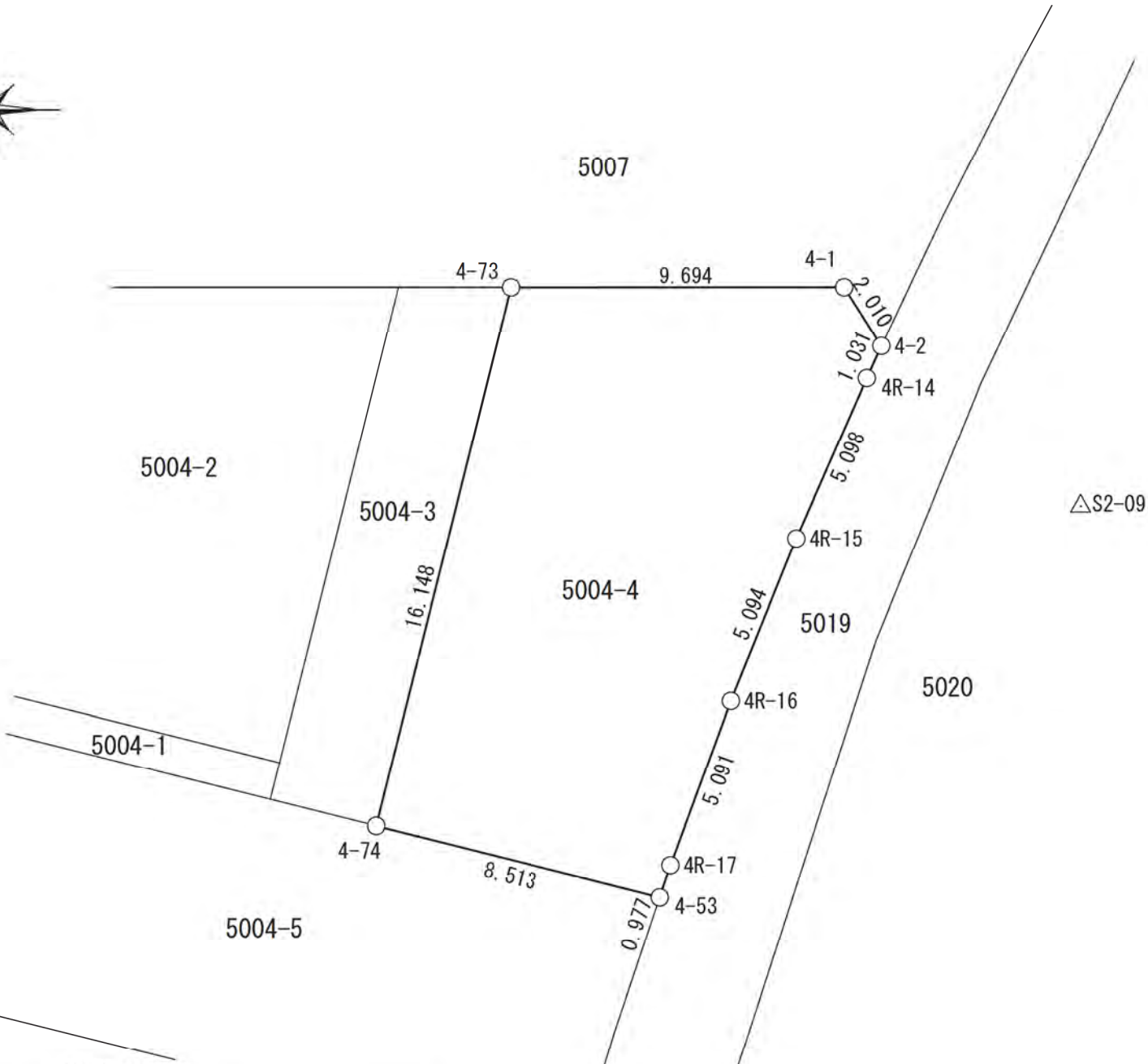

基準点網図

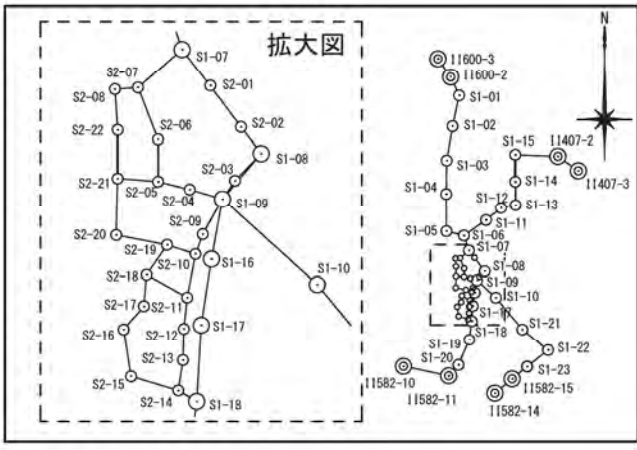

△S2-10

地 番 5004-5

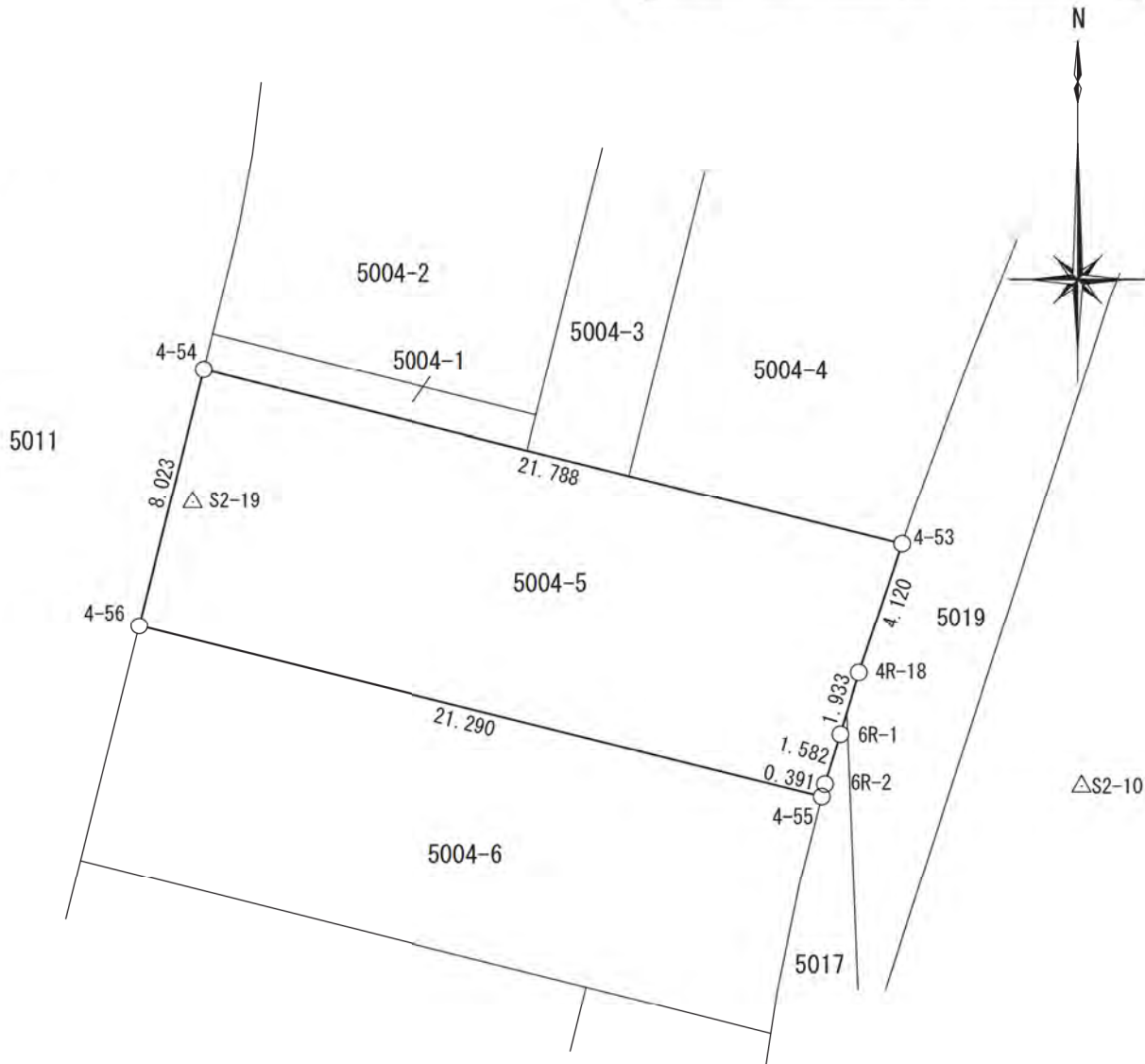

基準点網図

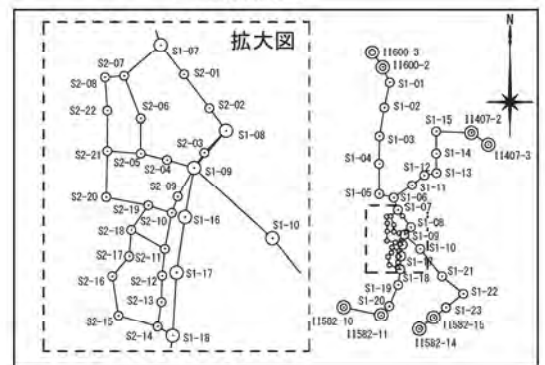

地 番 5004-6

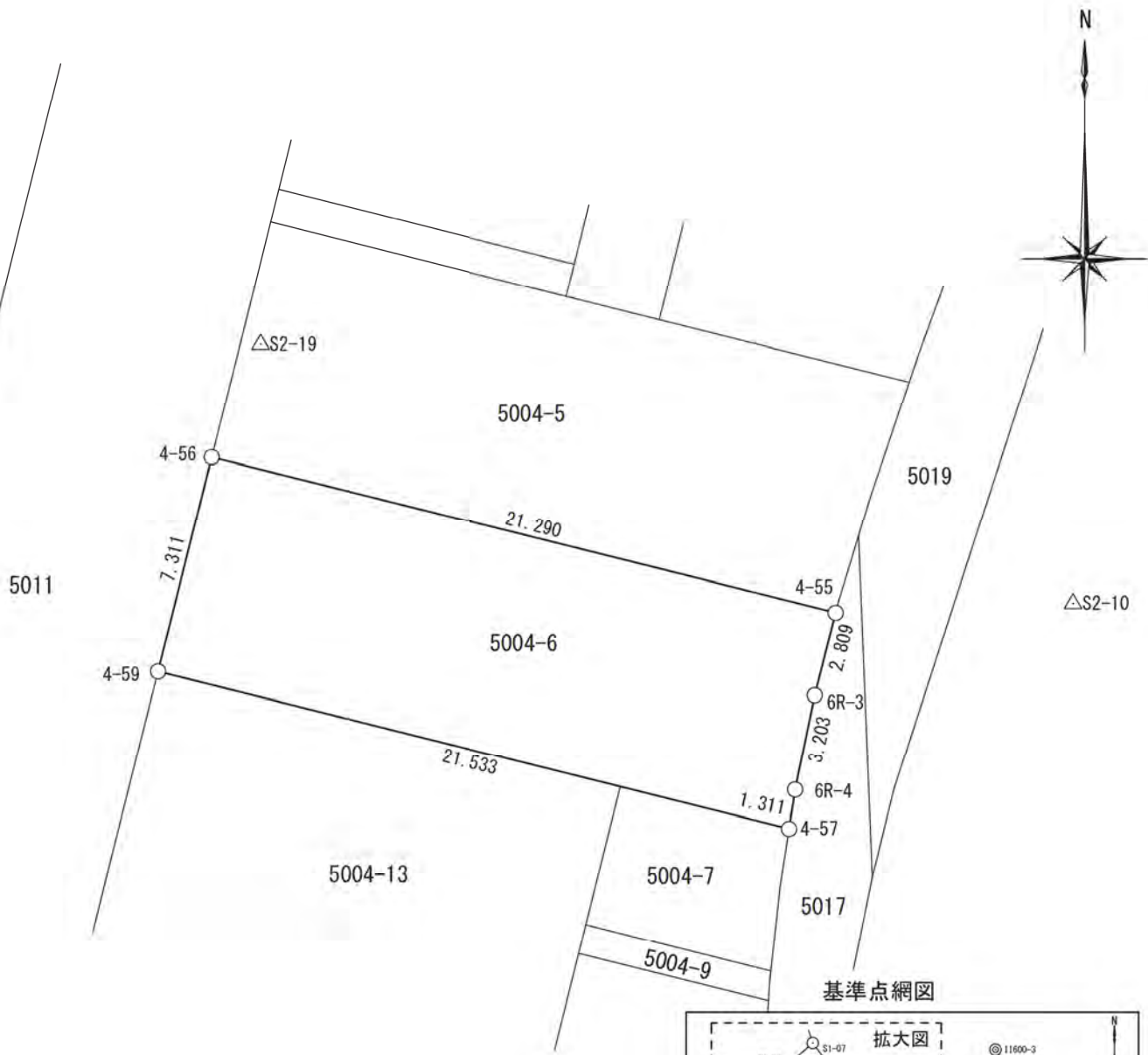

基準点網図

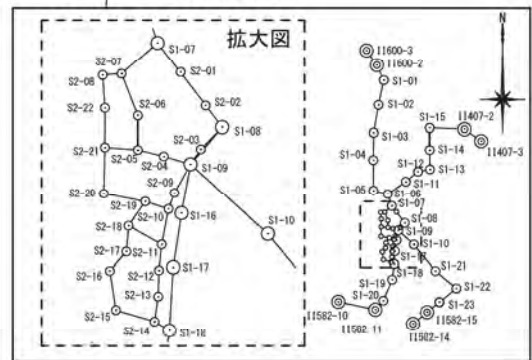

地番 5004-7

△ S2-19

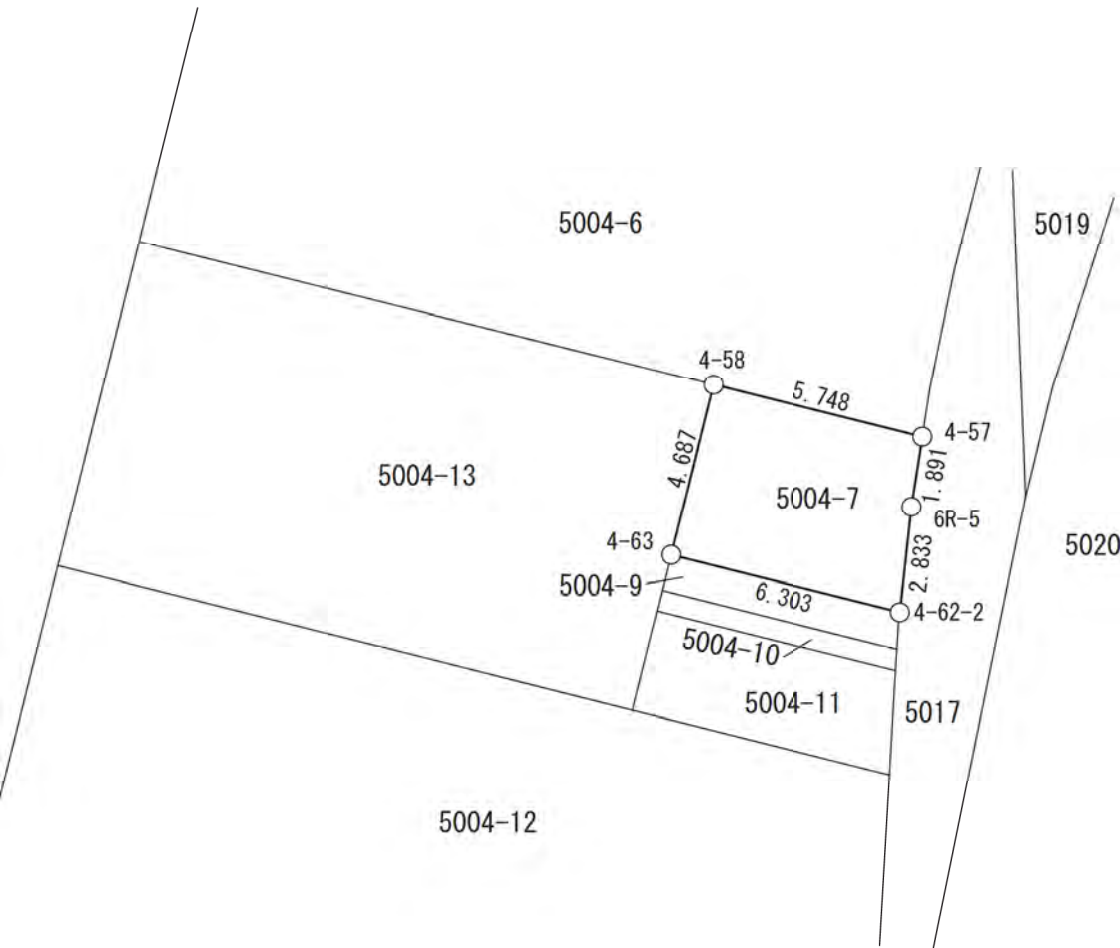

基準点網図

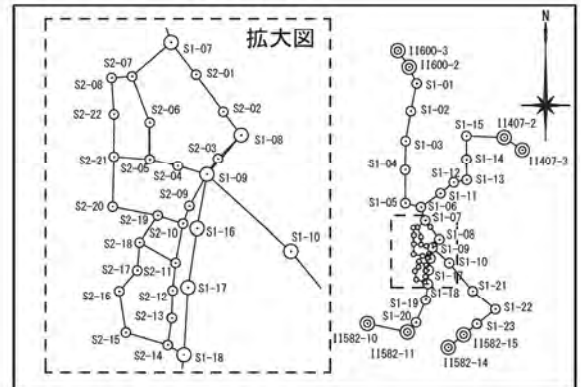

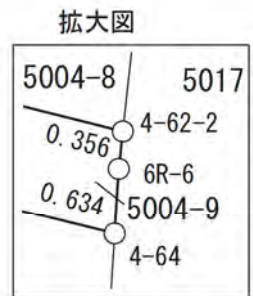
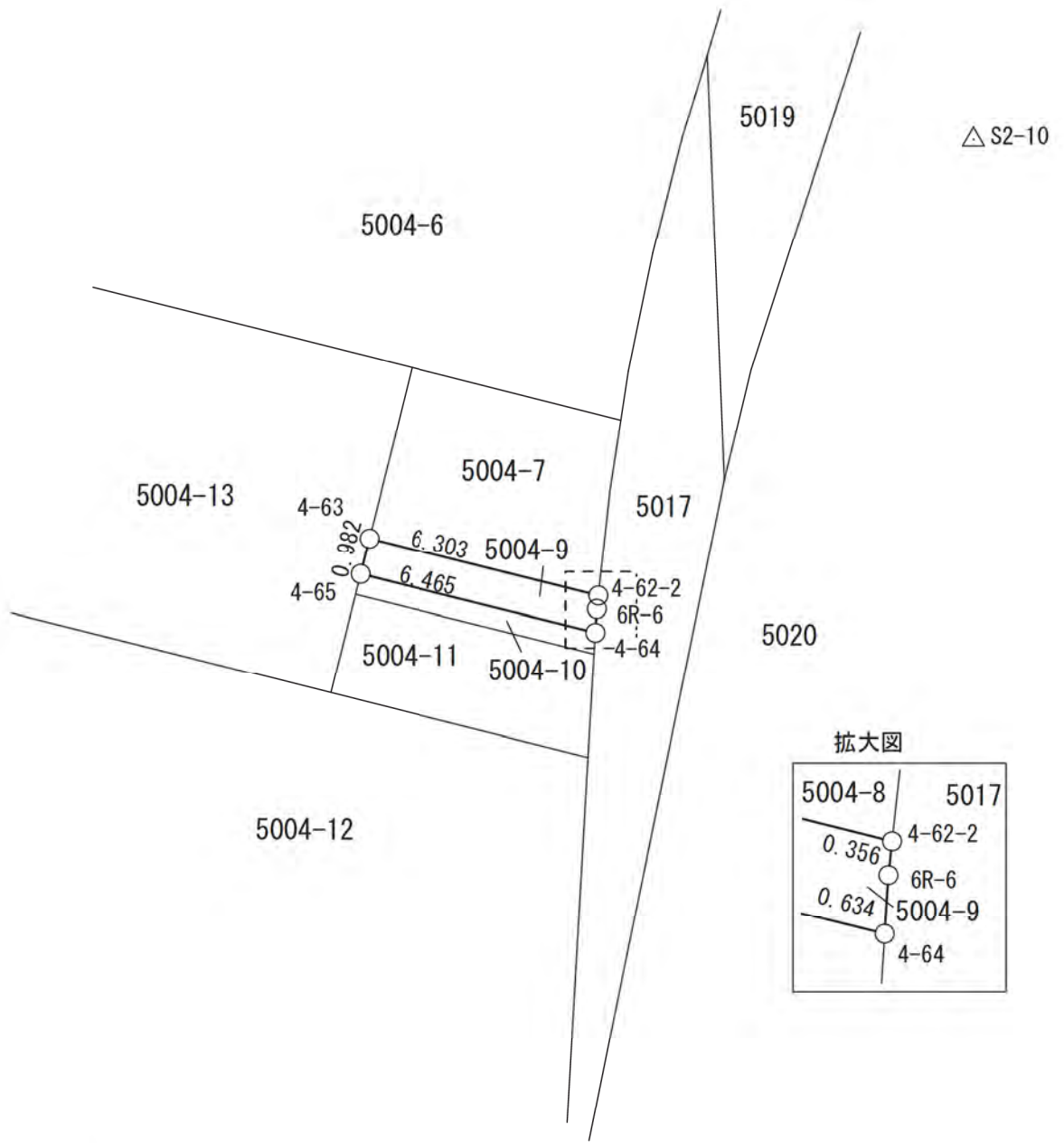

基準点網図

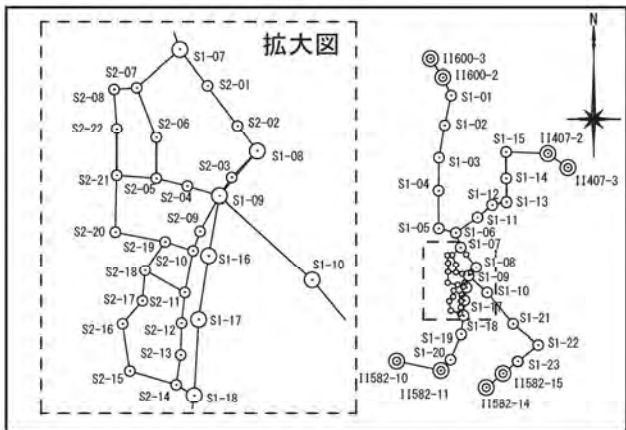

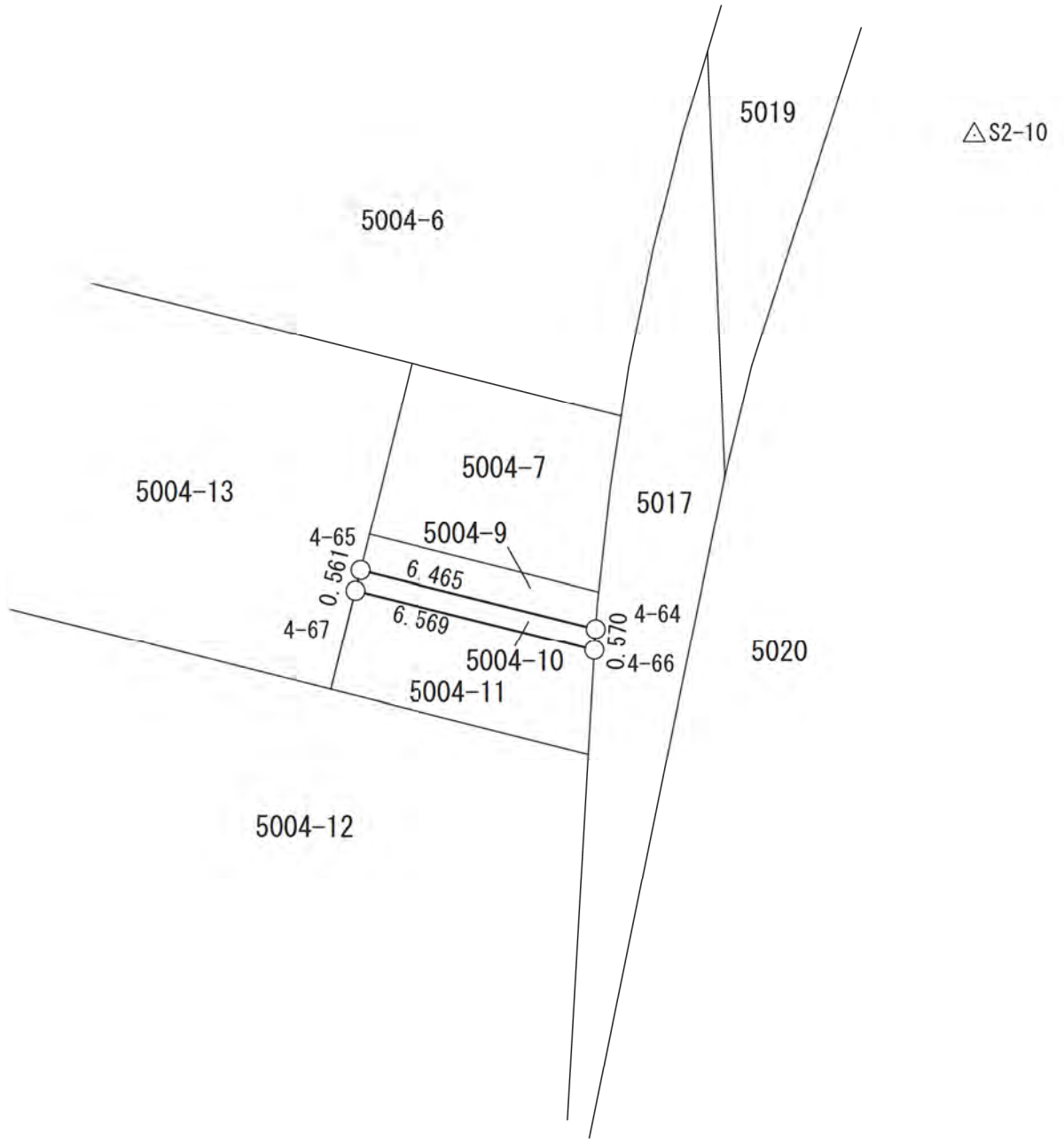

基準点網図

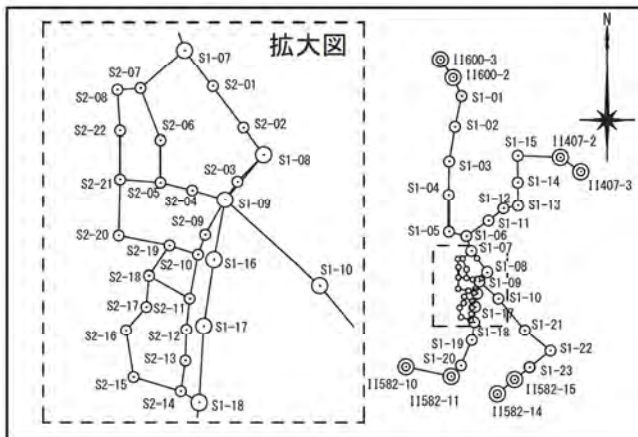

△S2-10

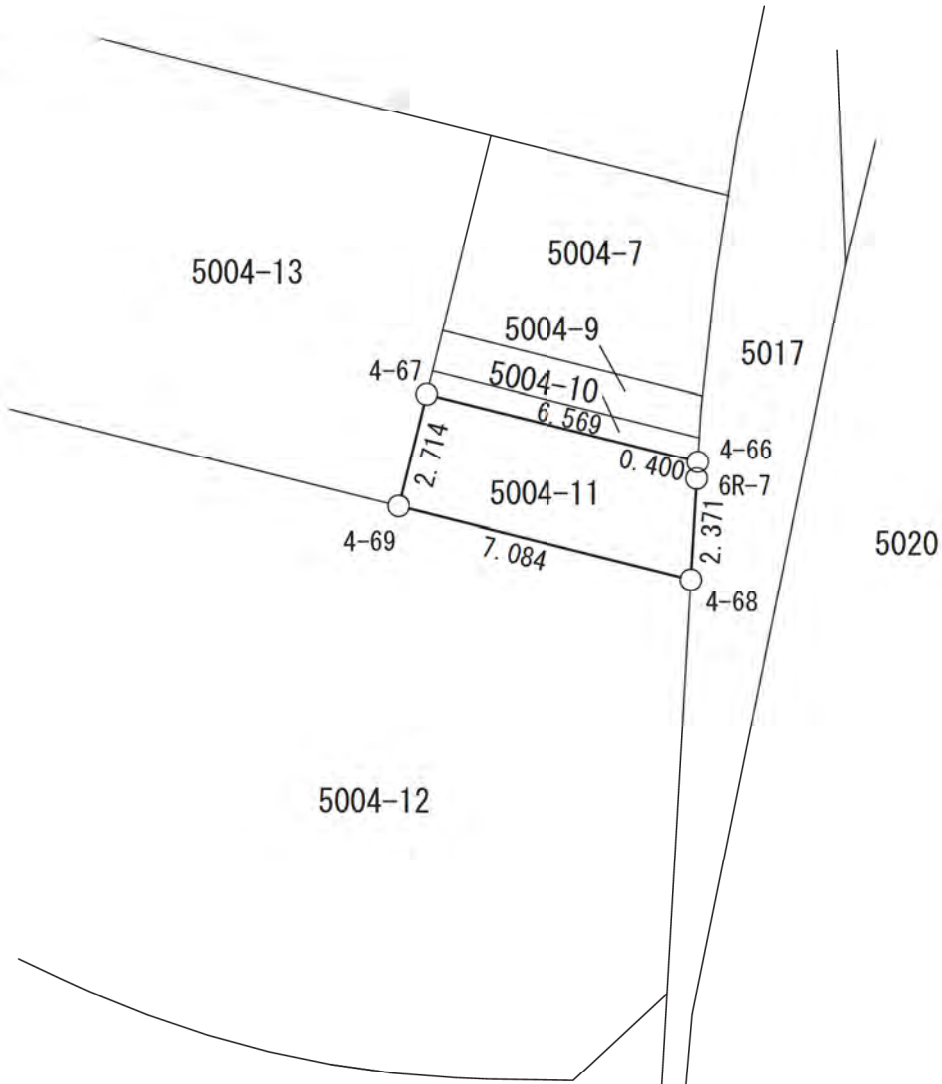

基準点網図

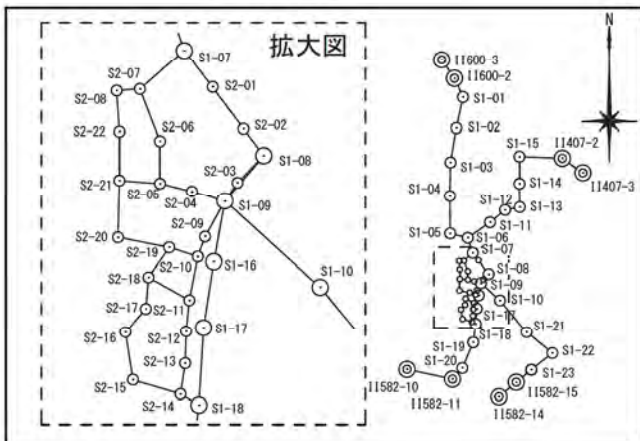

67

△S2-11

地番 5004-12

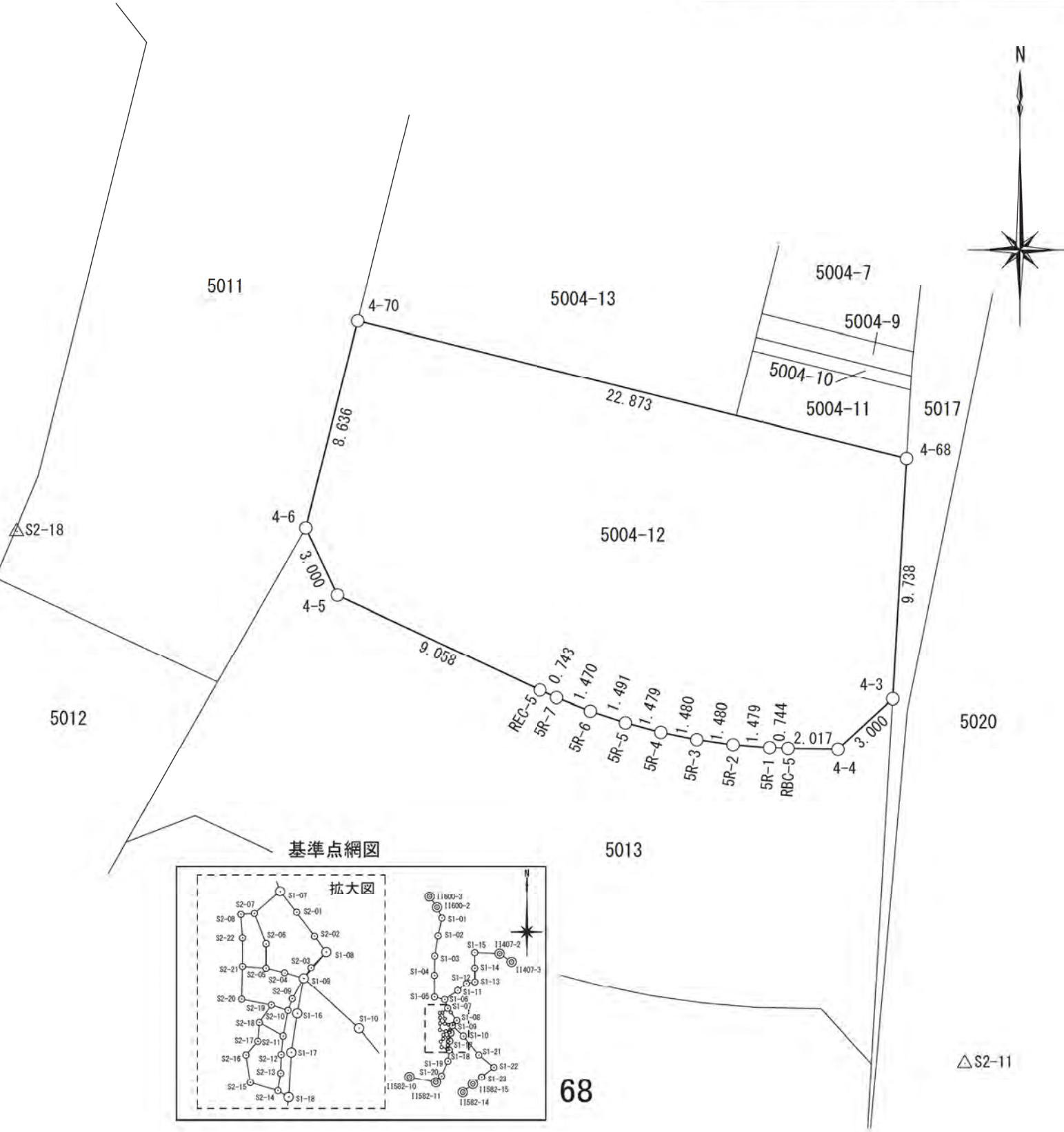

基準点網図

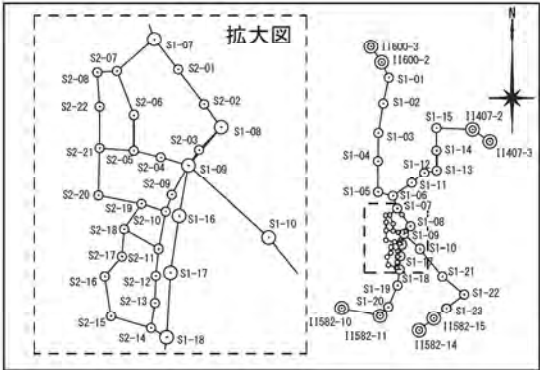

68

地 番 5004-13

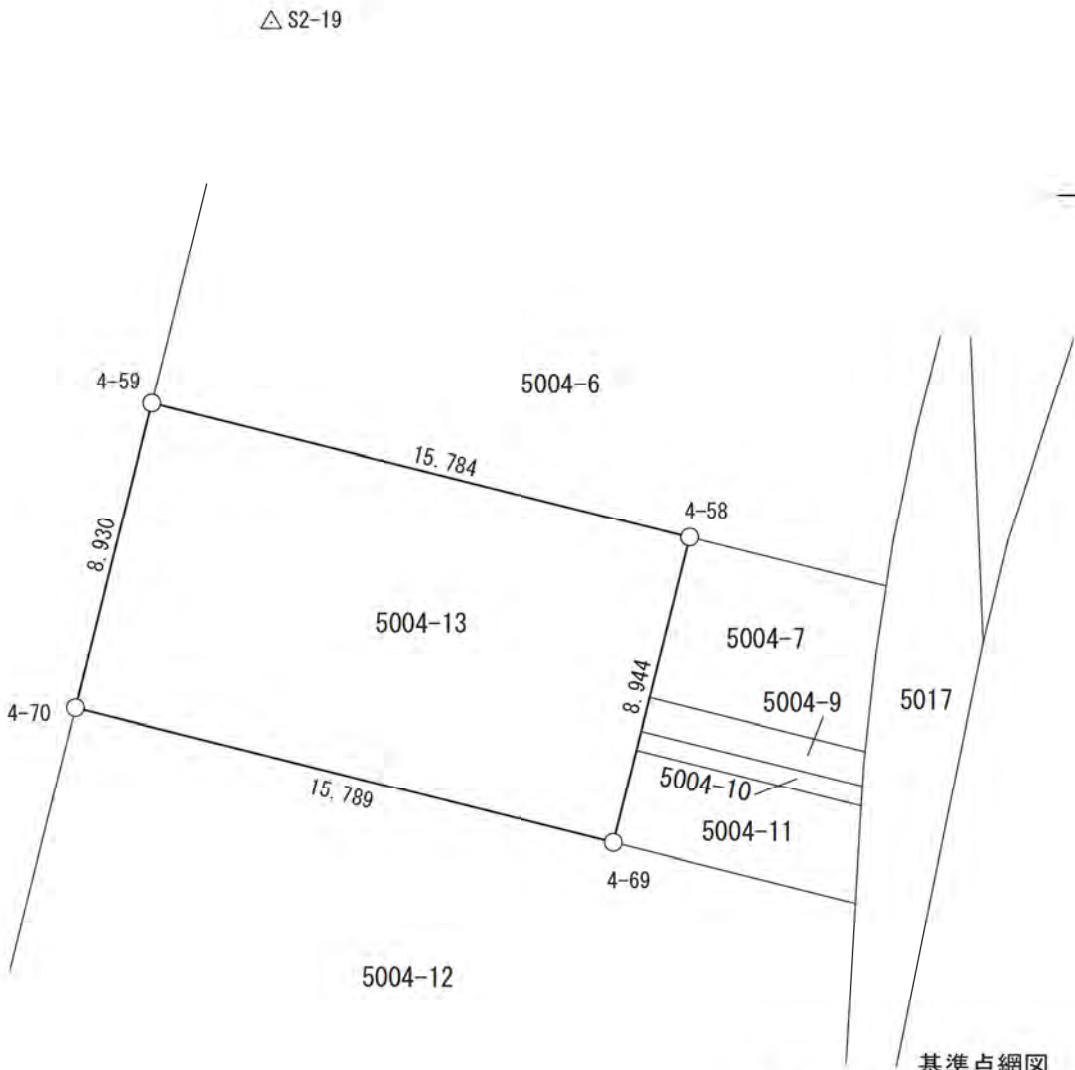

基準点網図

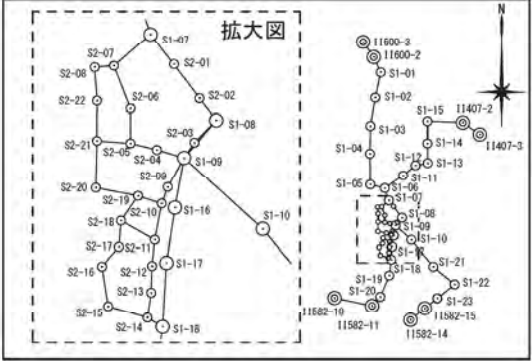

地 番

5005-1

△S2-18

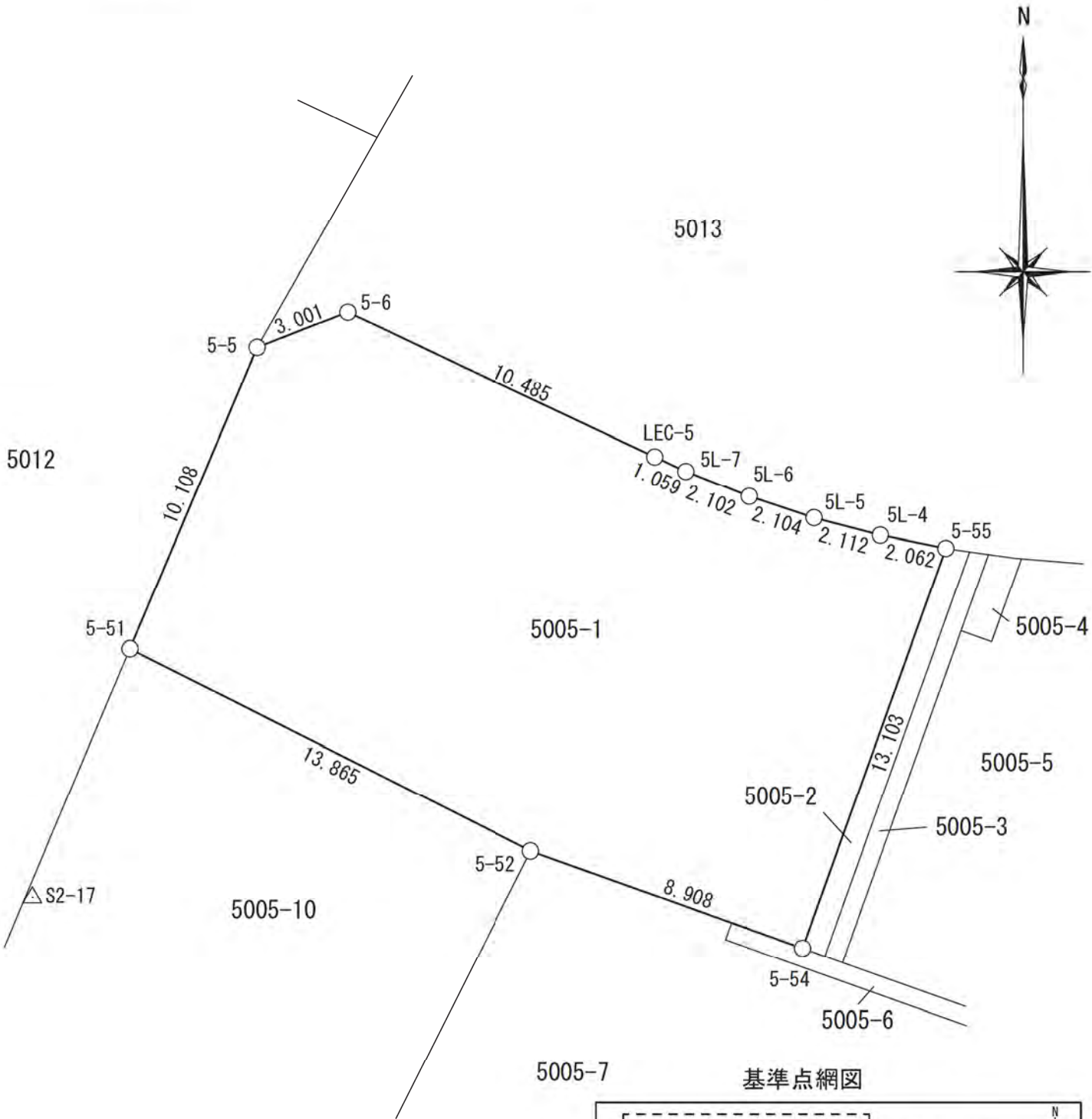

基準点網図

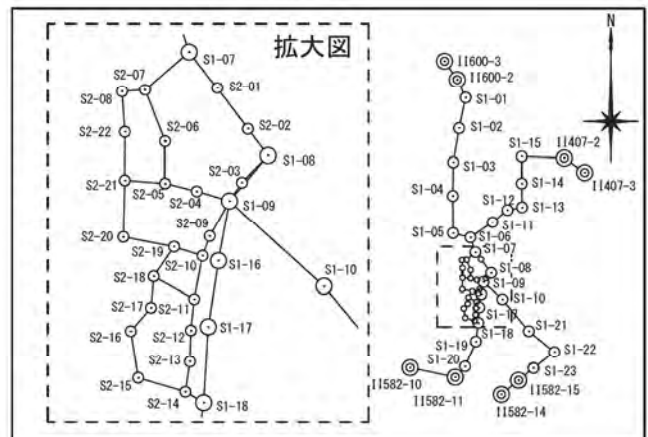

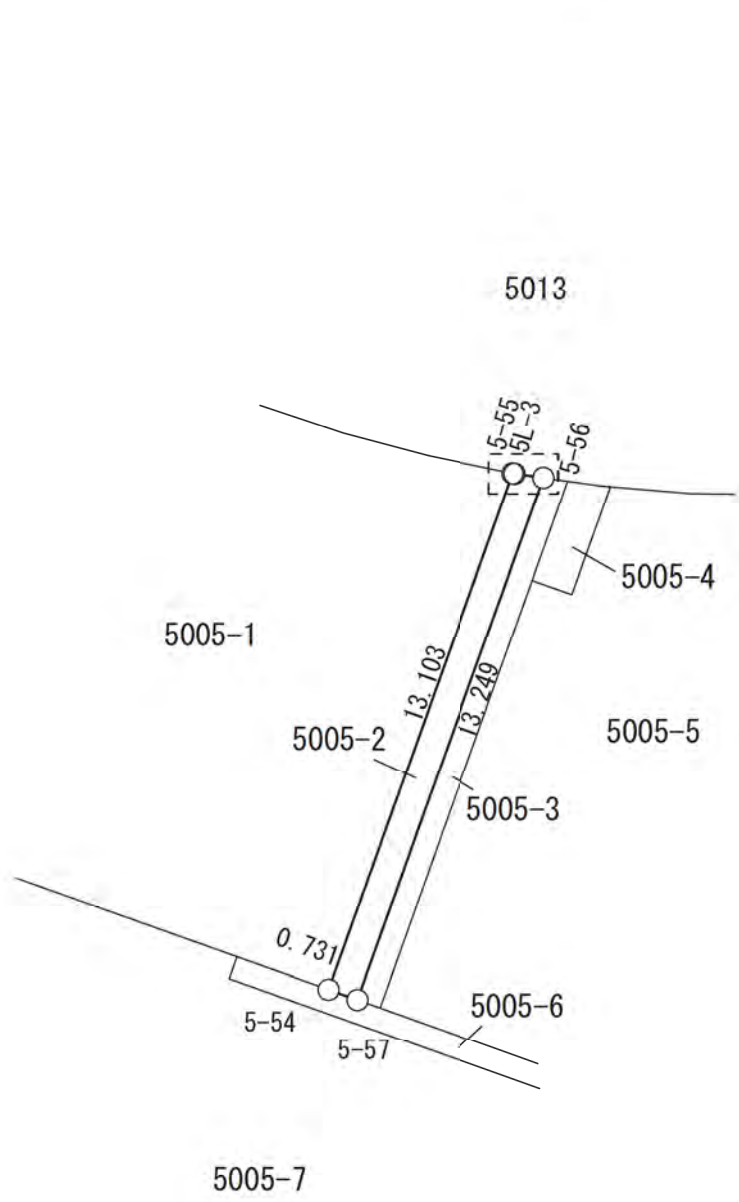

△S2-11

拡大図 1/50

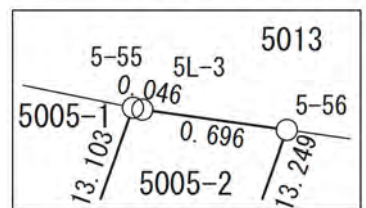

5005-7

基準点網図

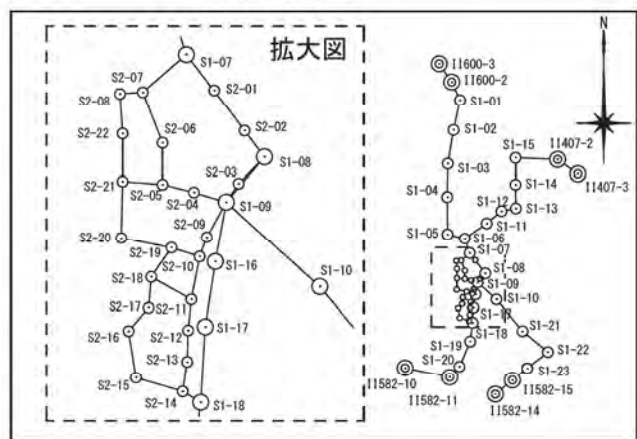

△ S2-12

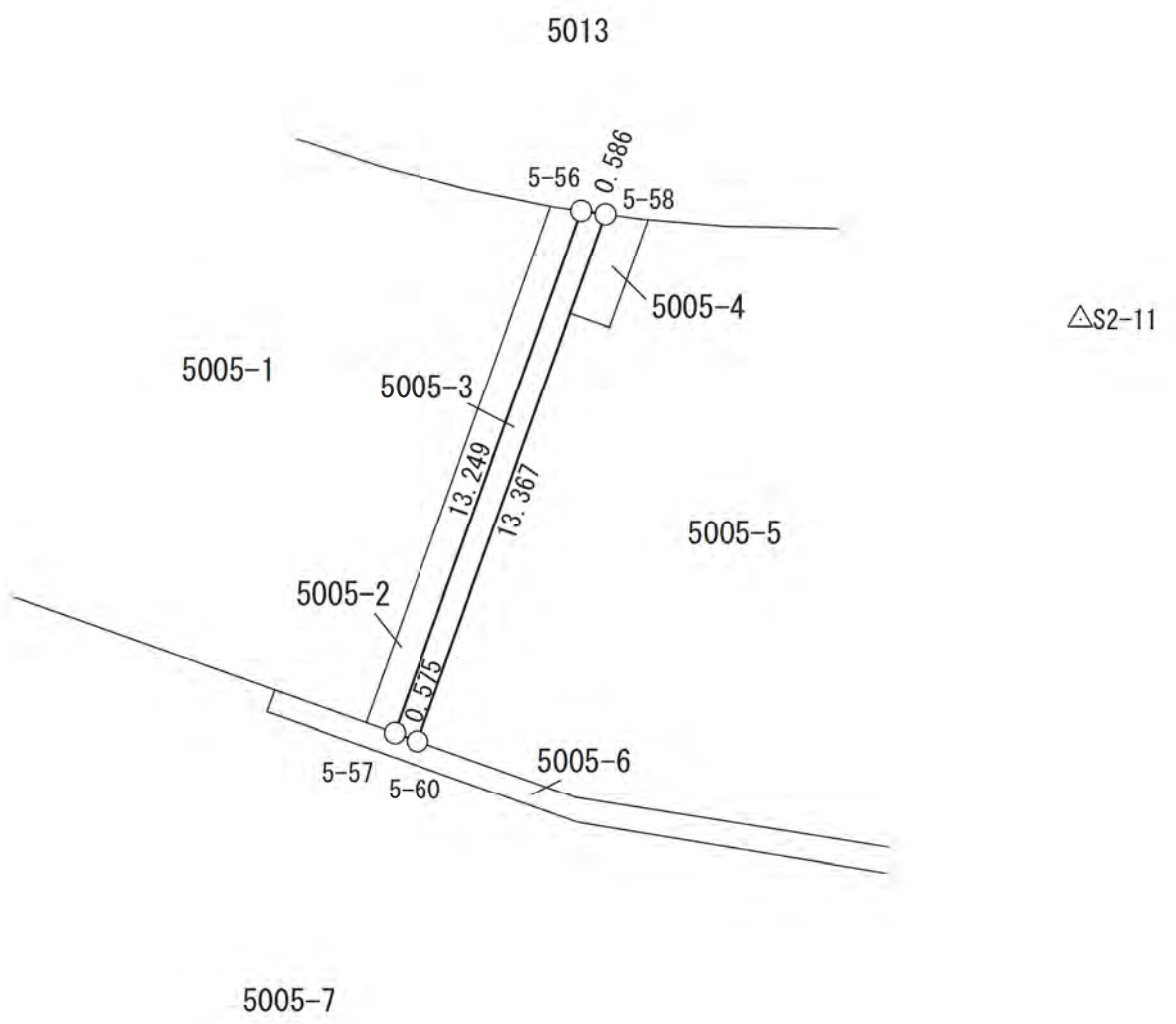

基準点網図

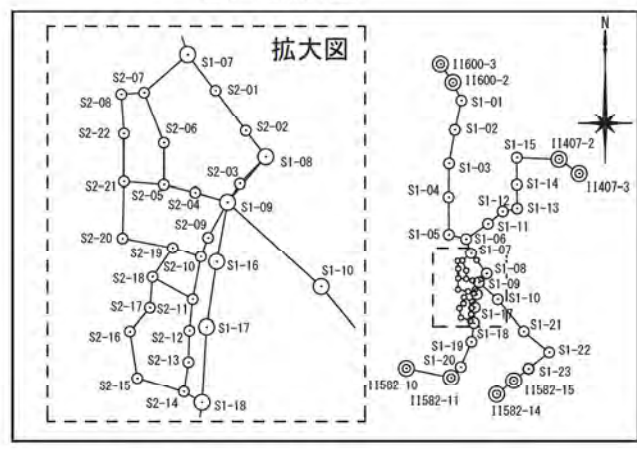



地 番 5005-4

拡大図

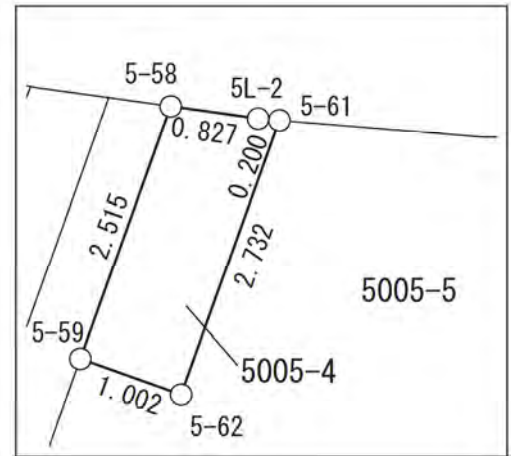

5013

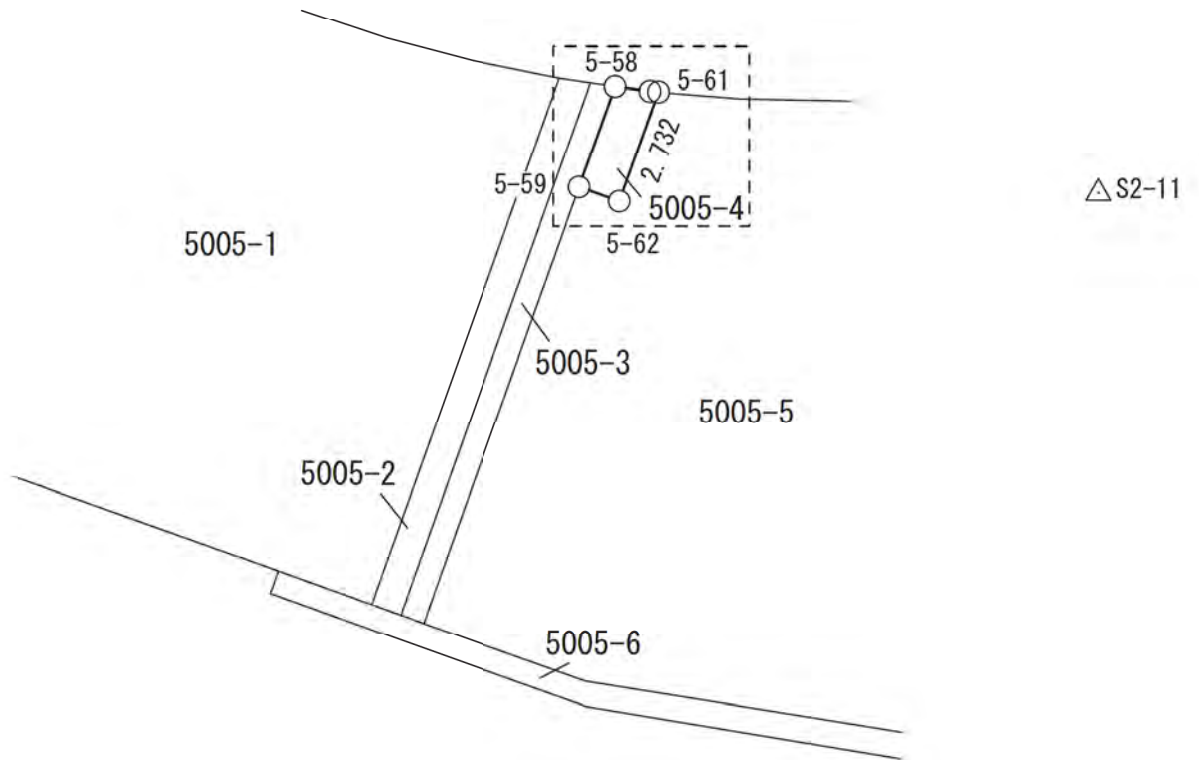

基準点網図

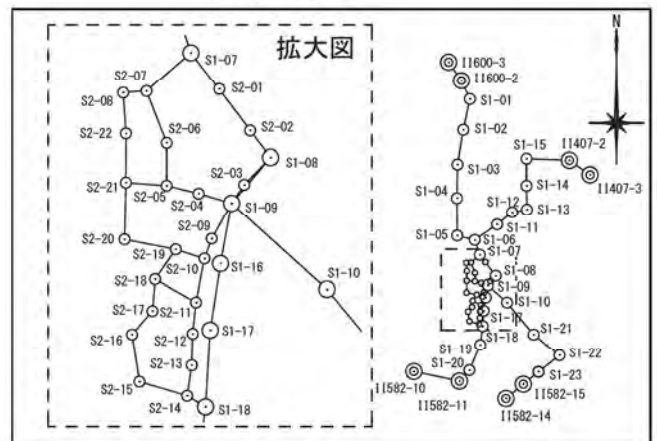

5005-7

地 番

5005-5

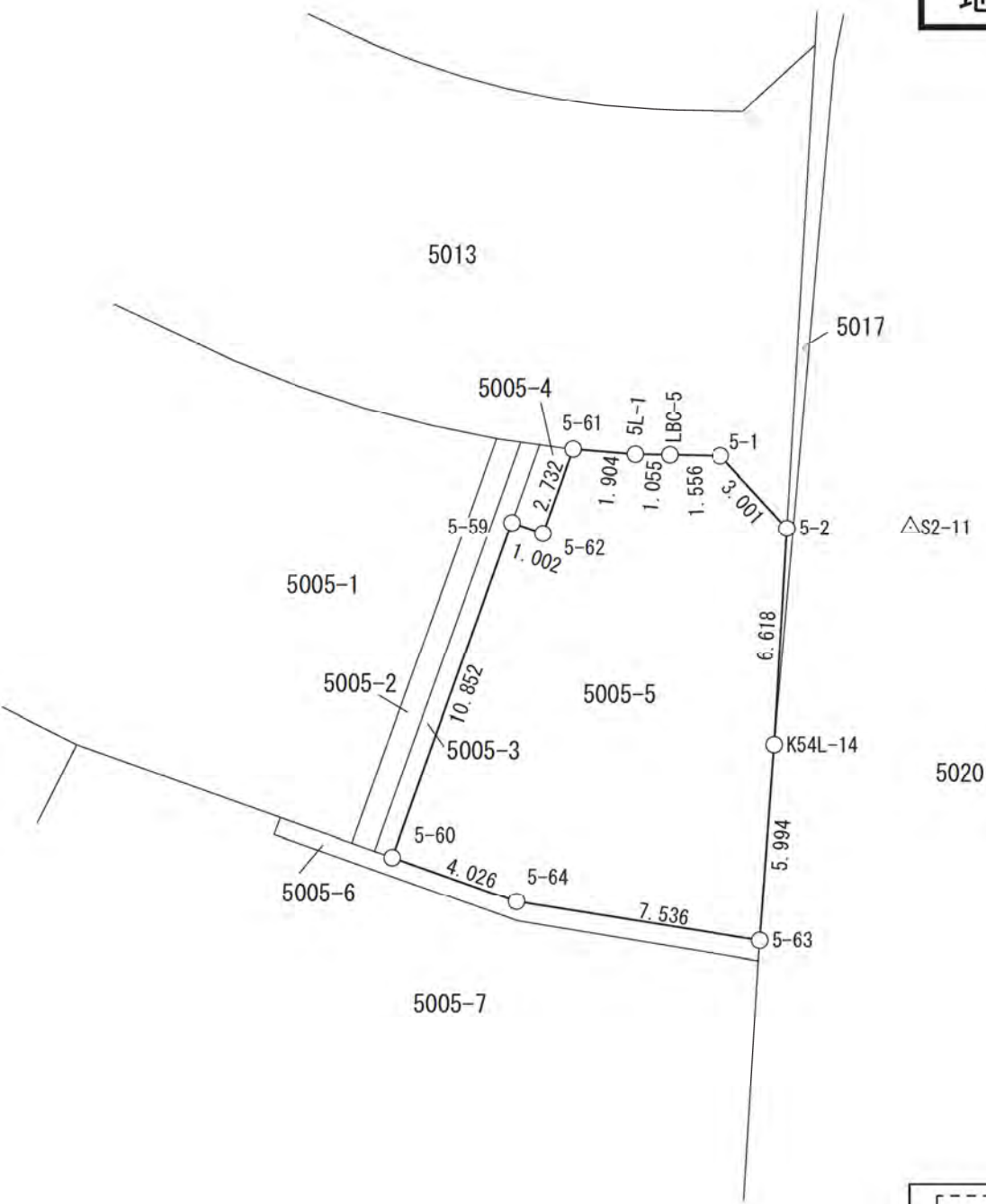

基準点網図

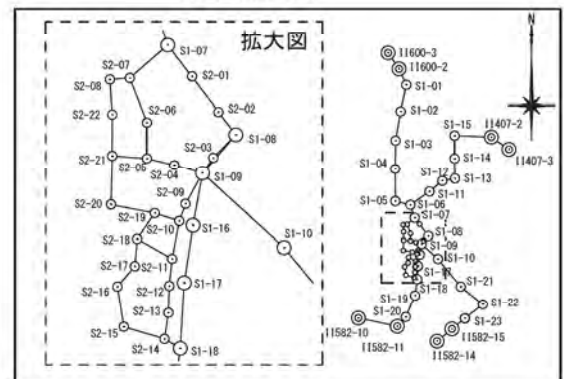

地番 5005-6



基準点網図

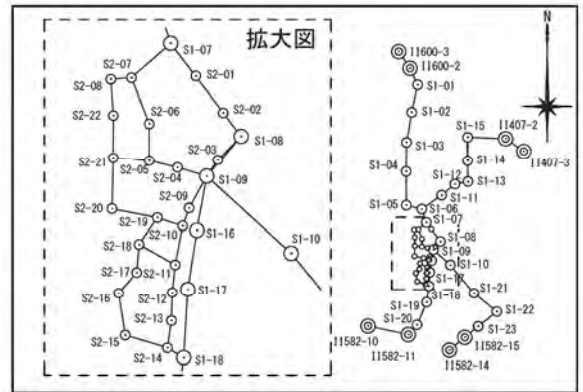

△S2-12

75

地番 5005-7

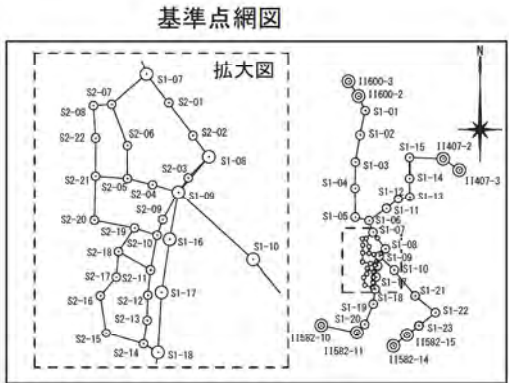
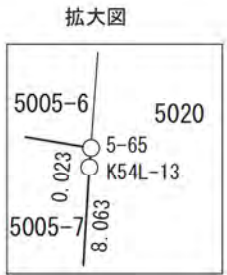
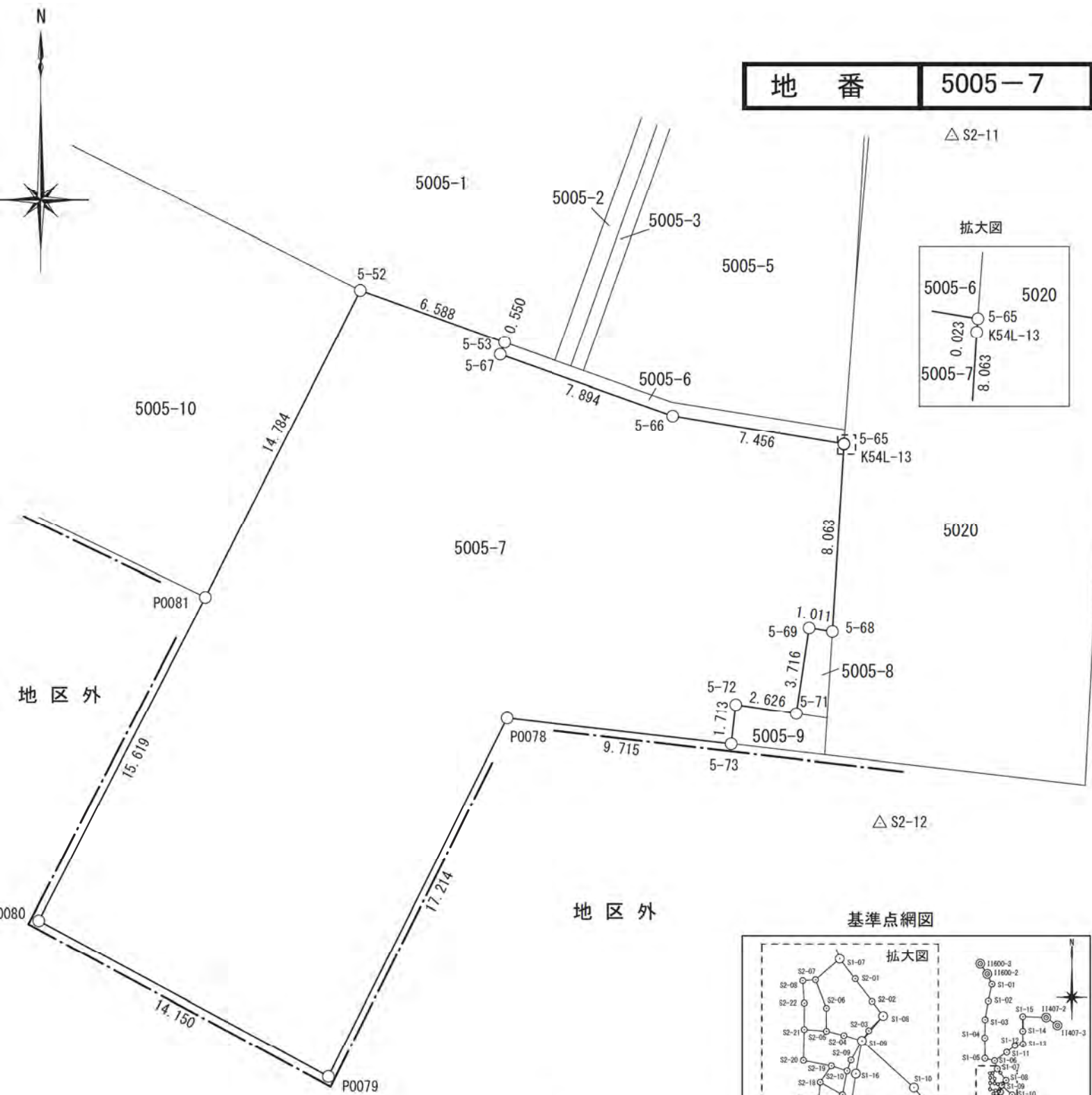

地番 5005-8

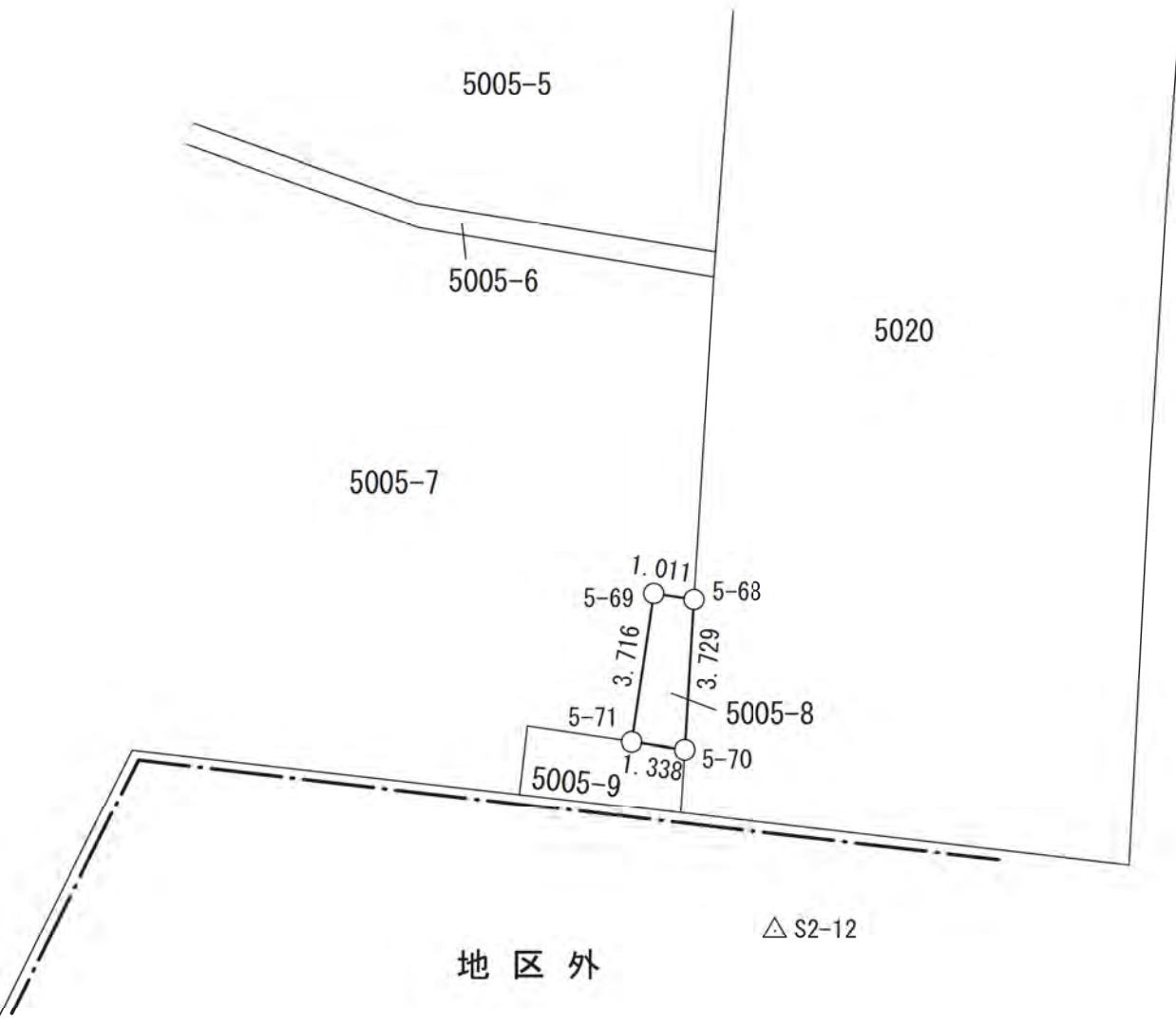

基準点網図

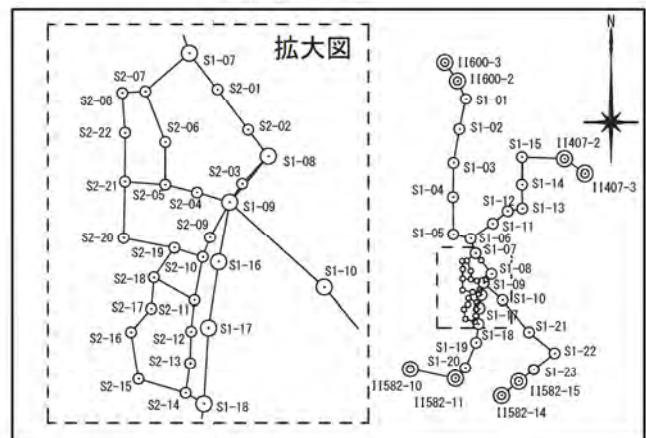

地番 5005-9

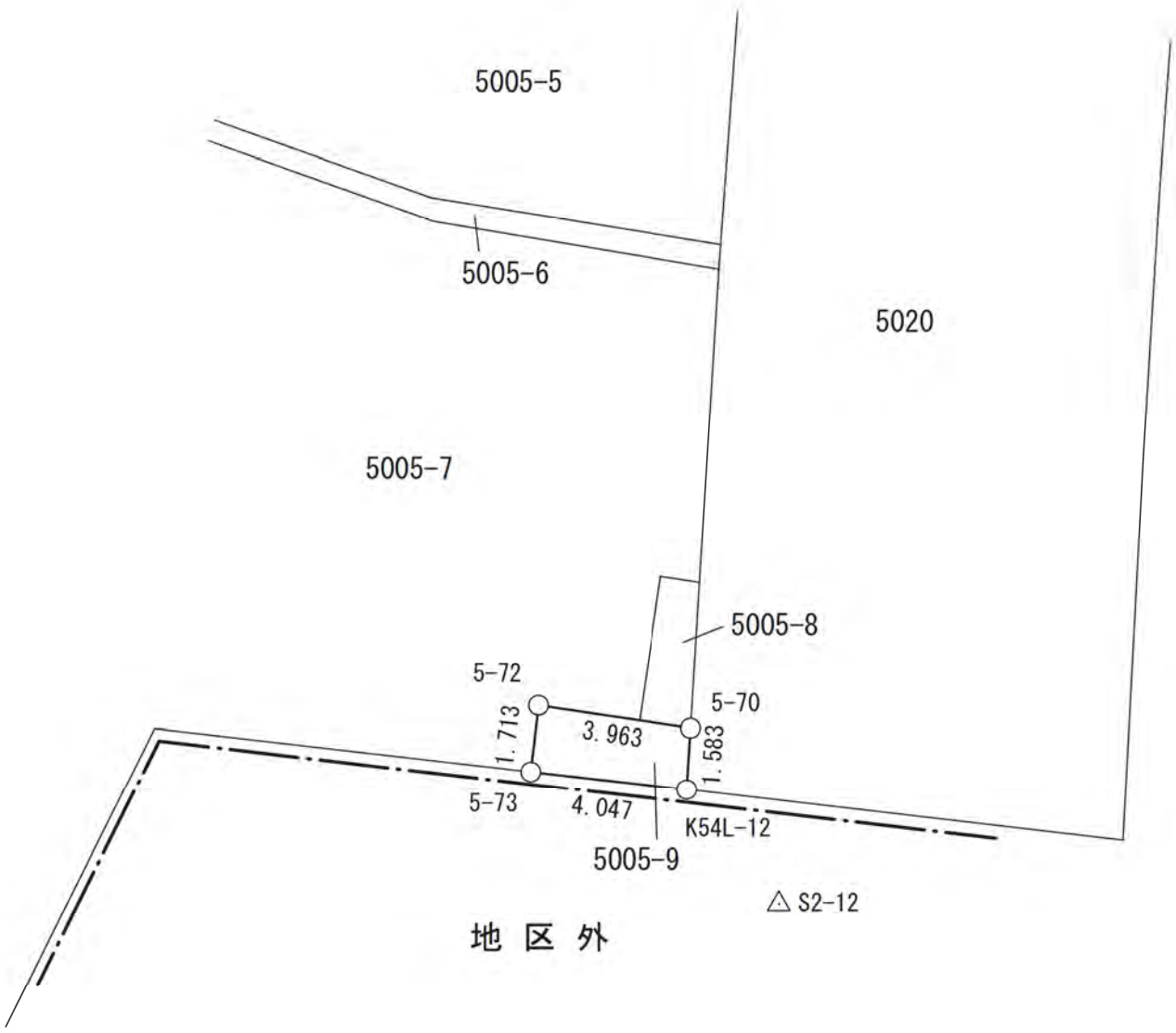

基準点網図

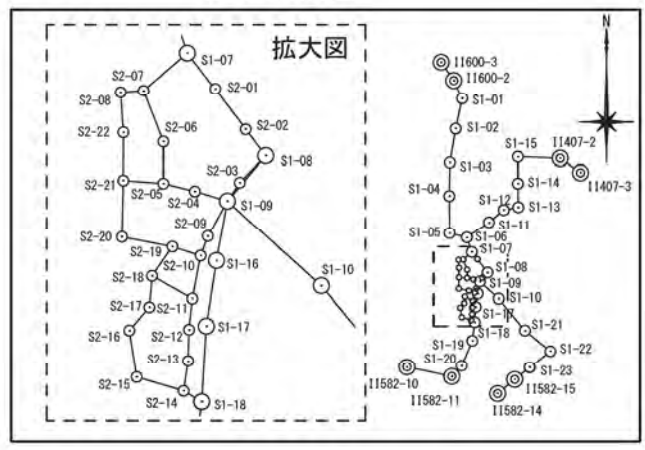

地番 5005-10

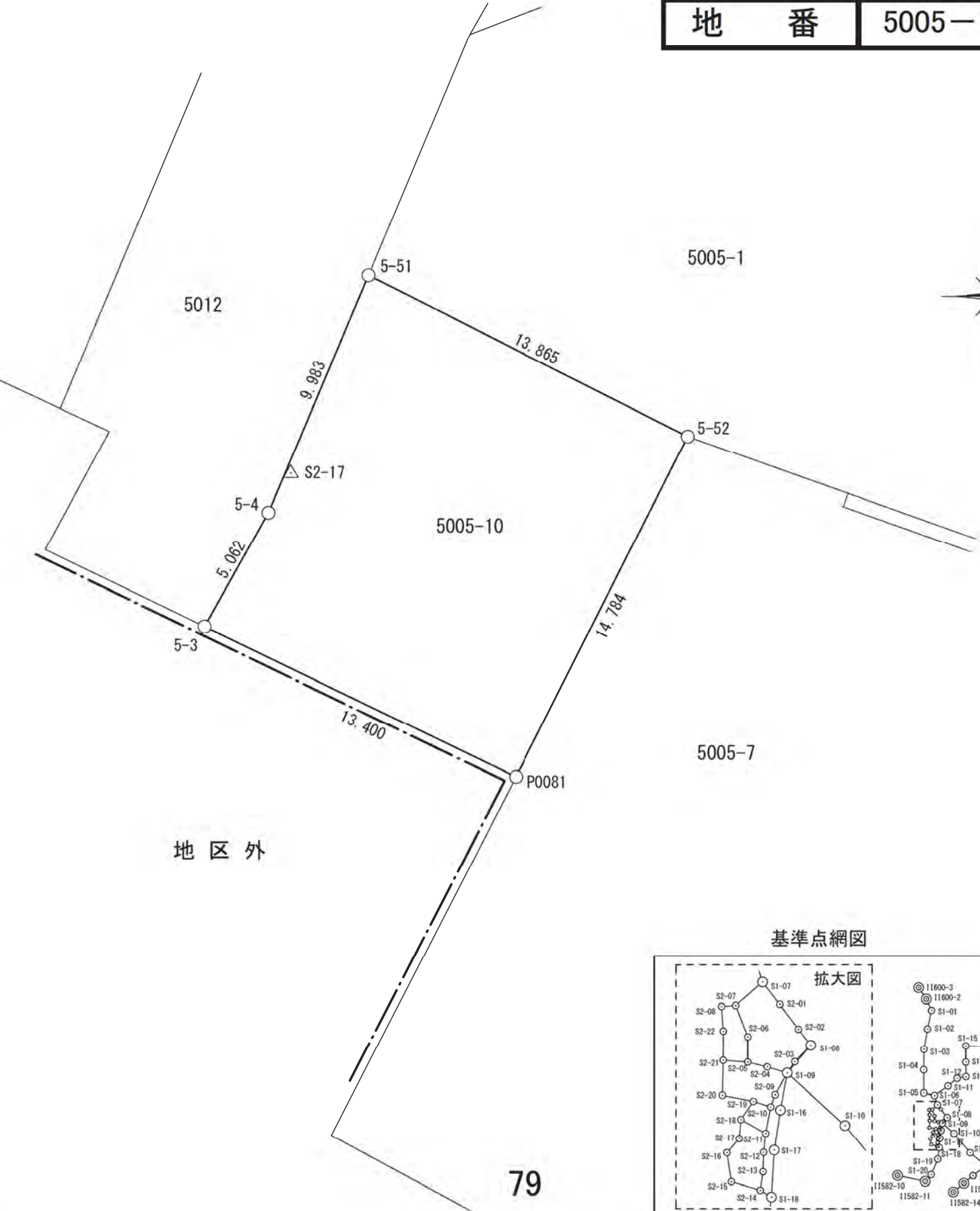

基準点網図

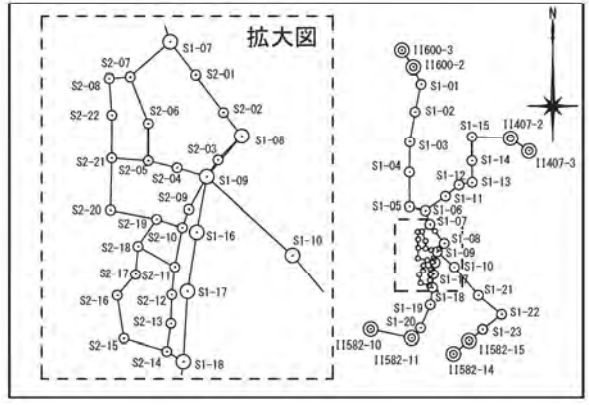

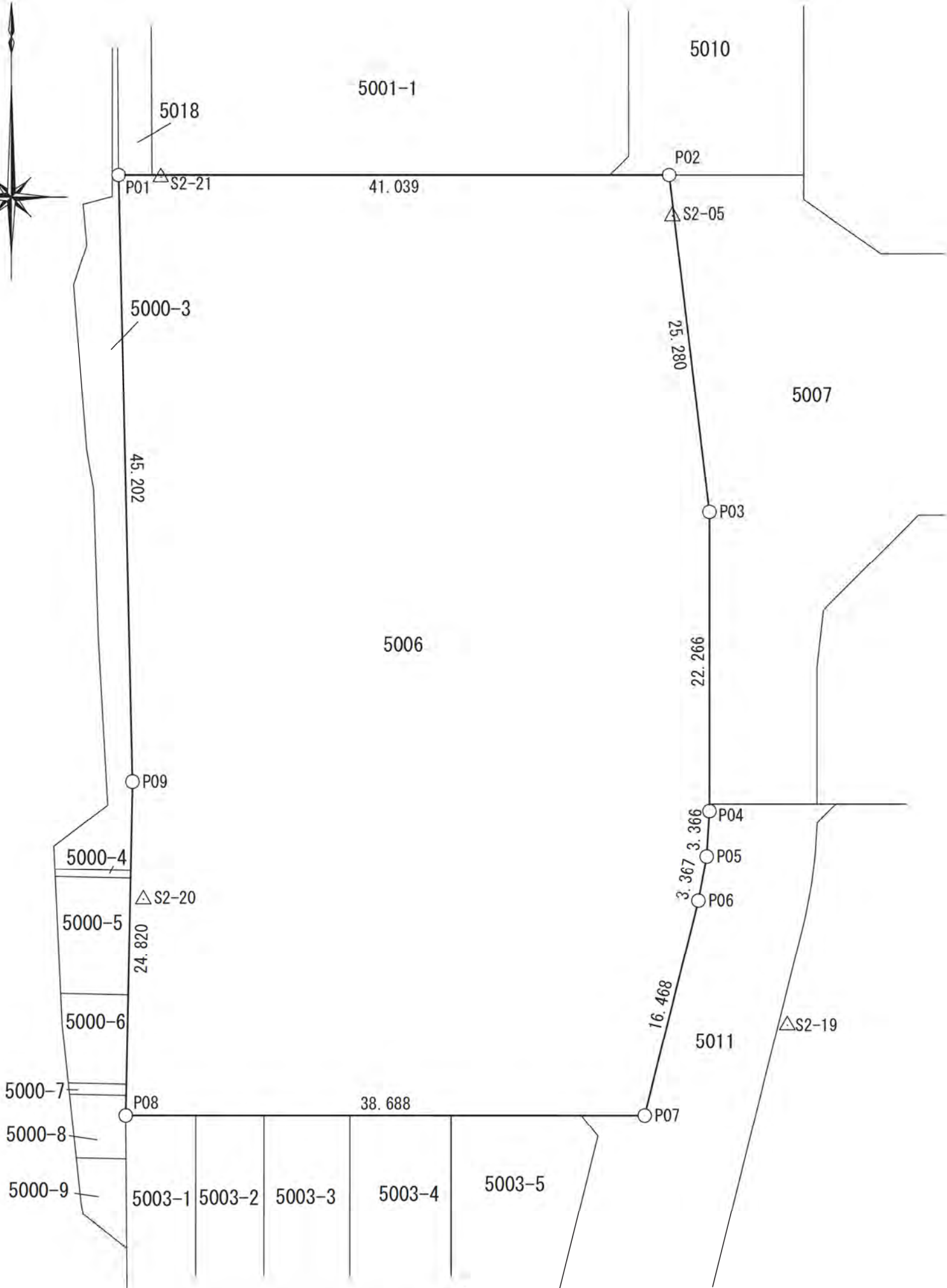

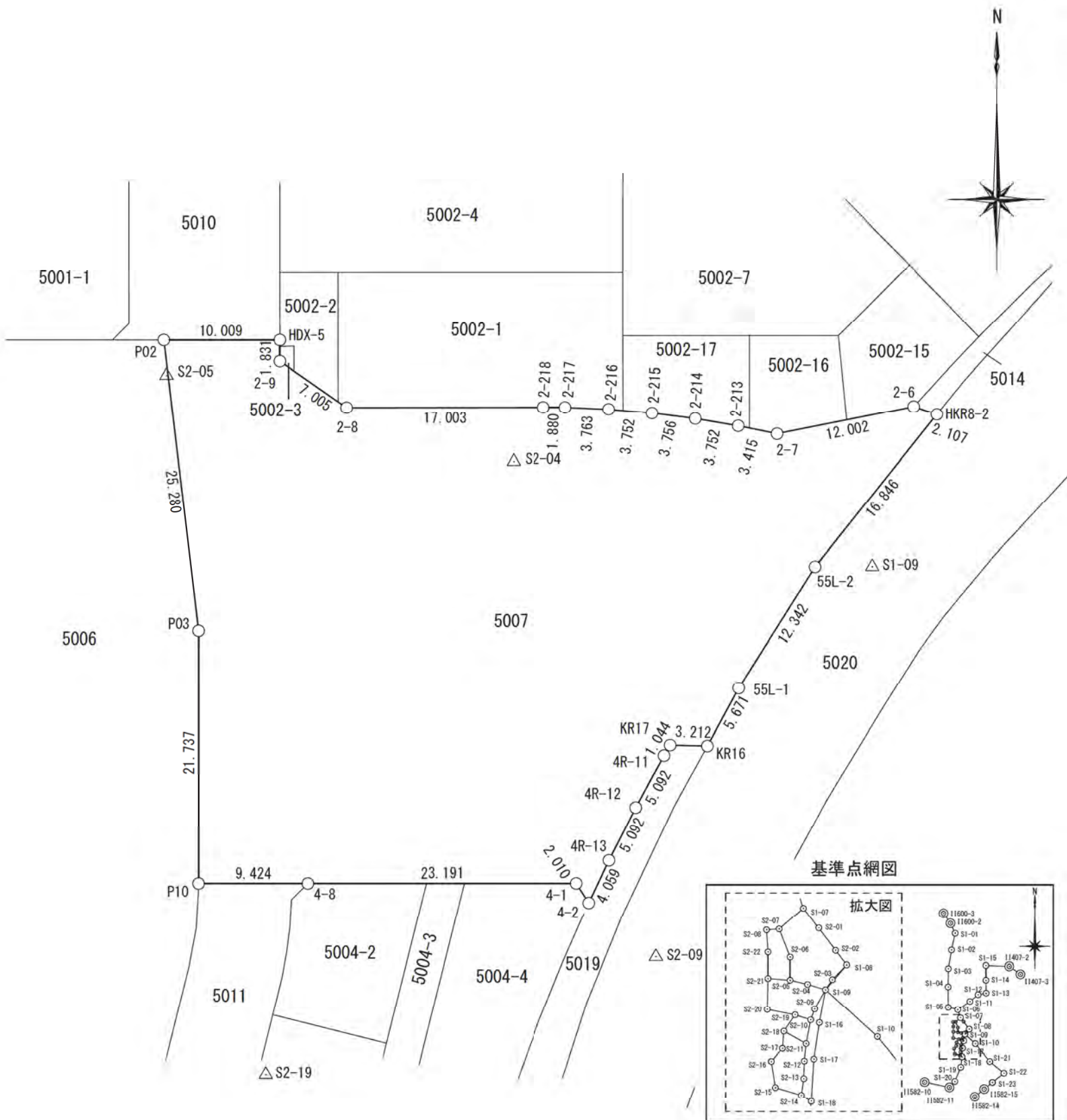

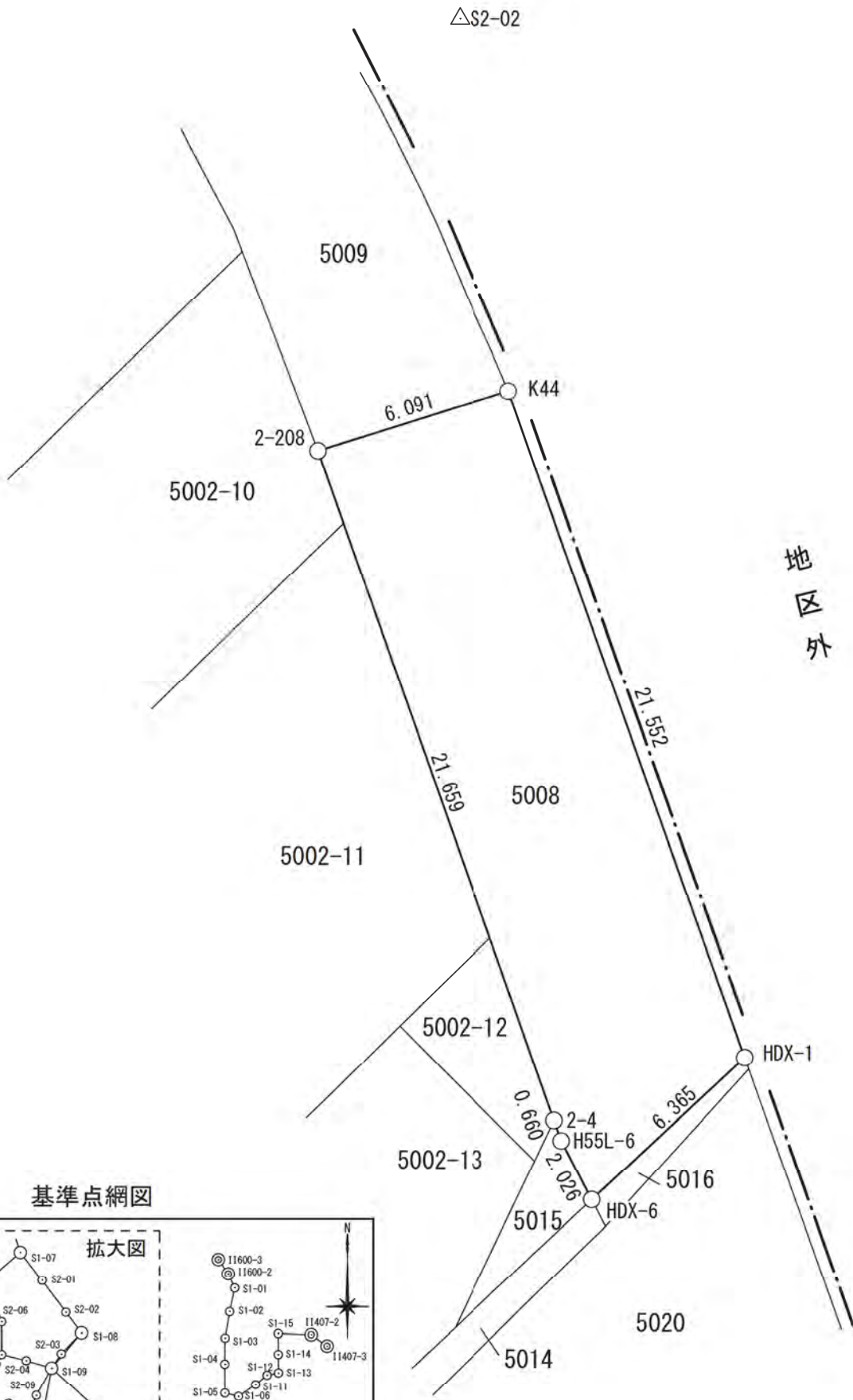

基準点網図

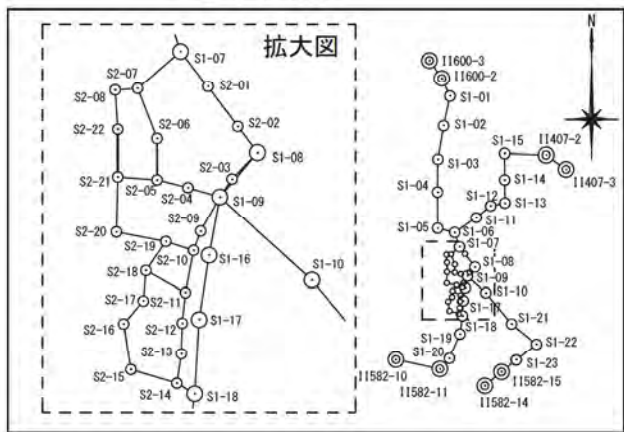

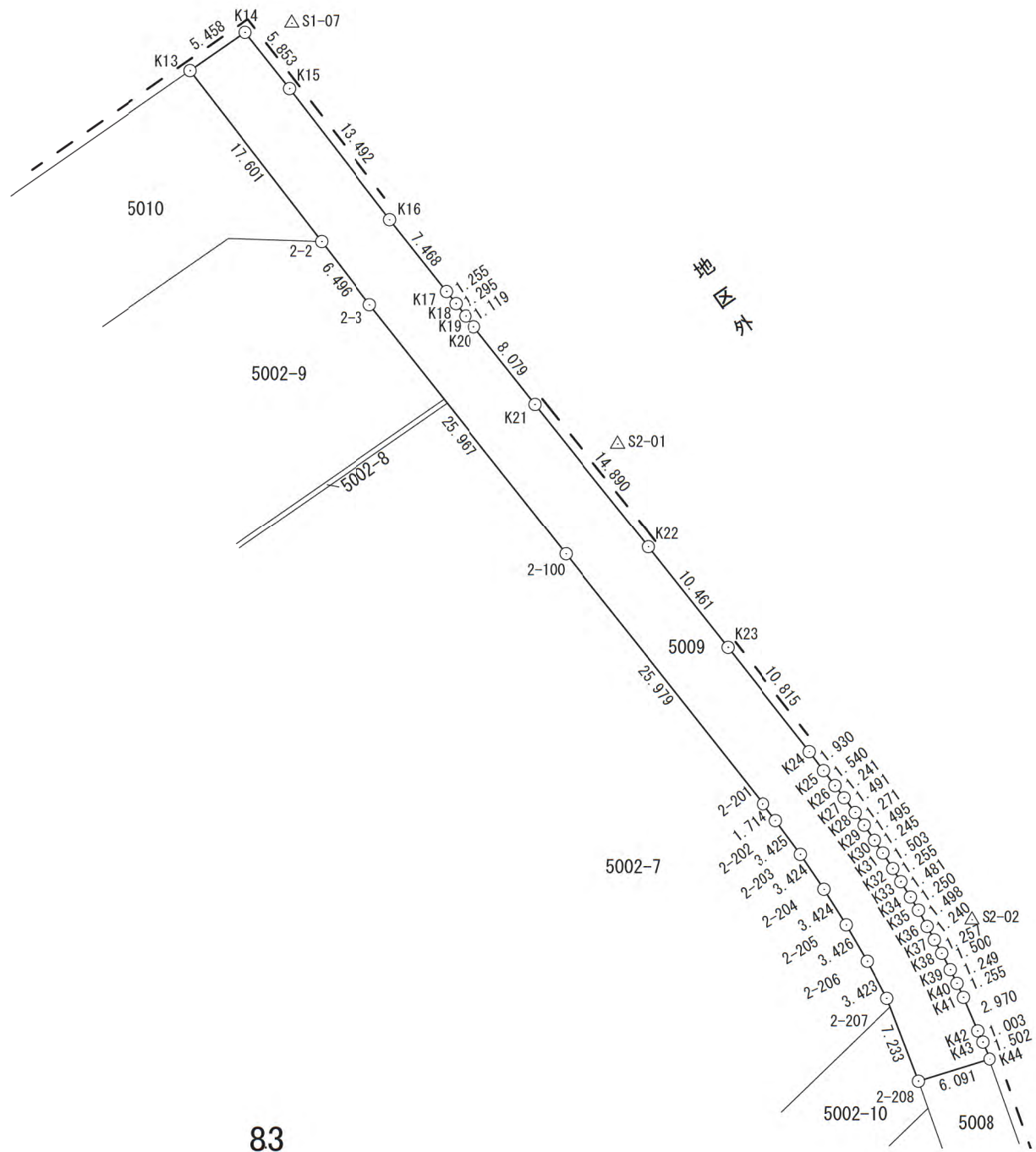

基準点網図

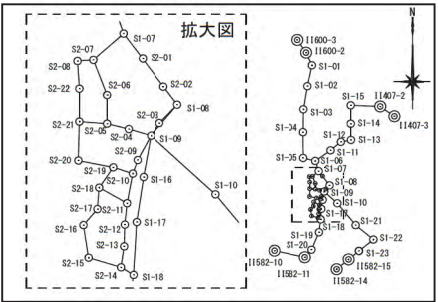

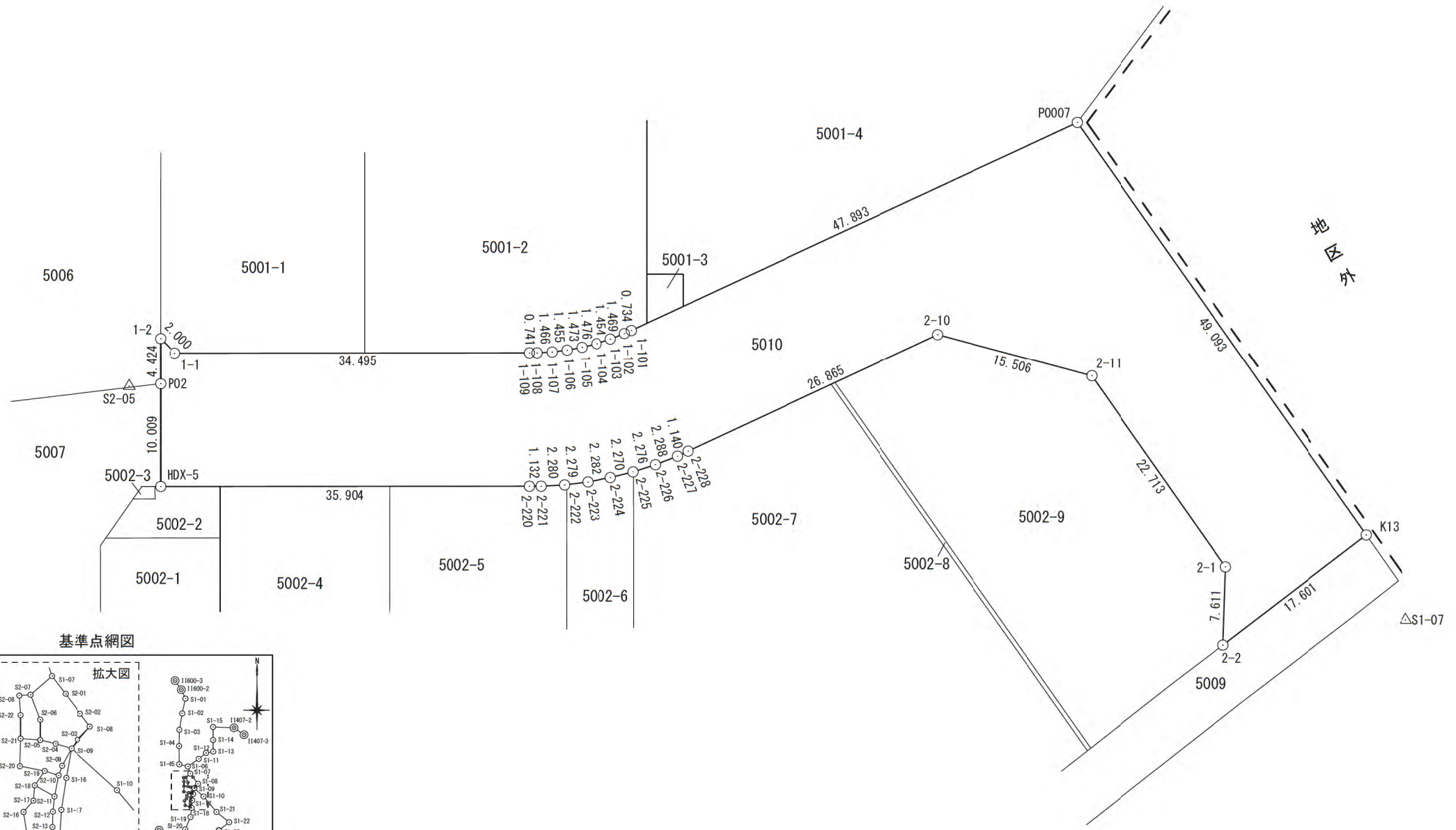

基準点網図

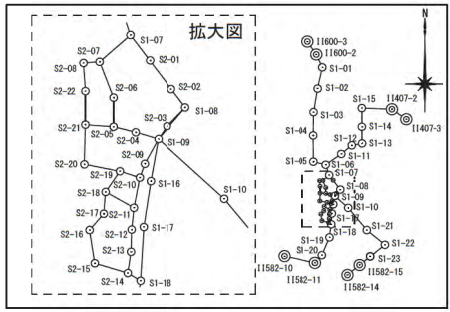

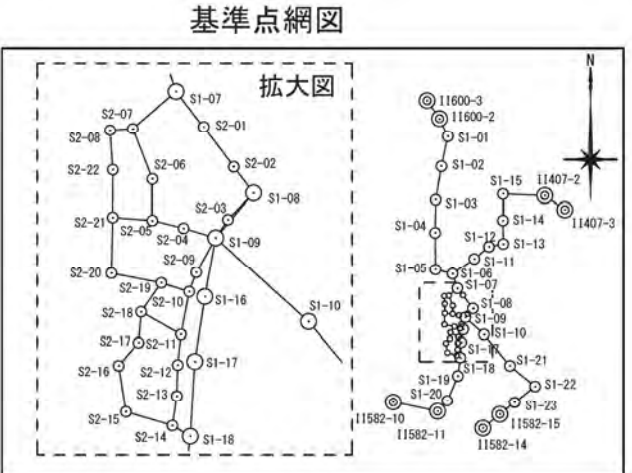
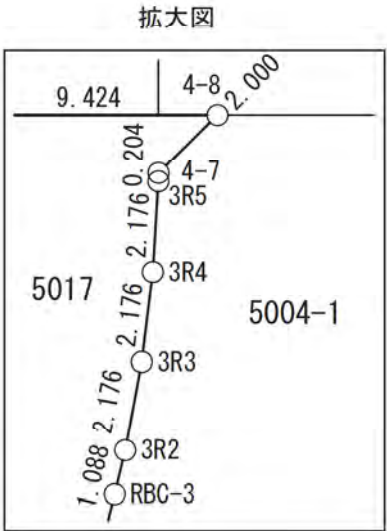
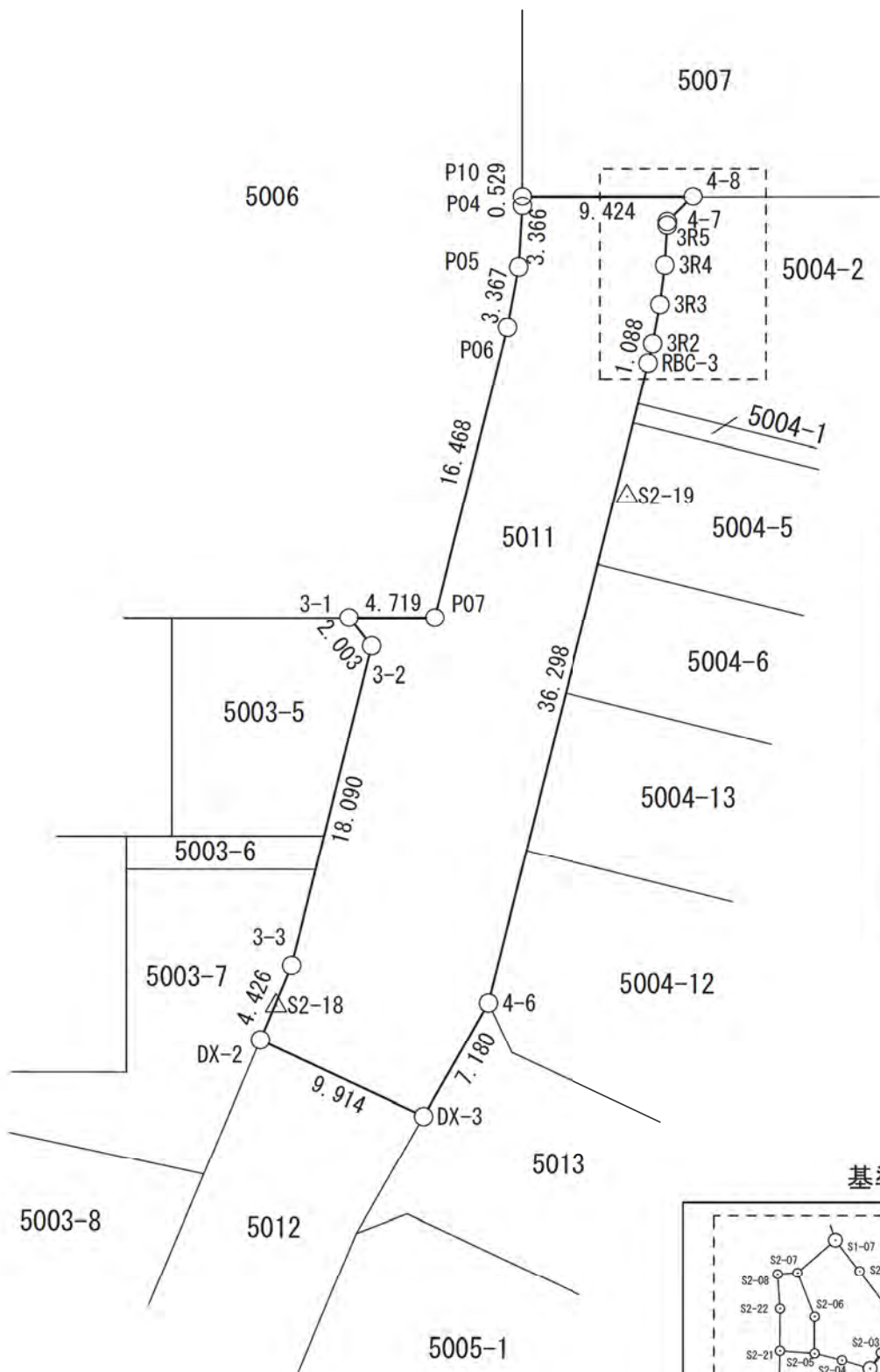

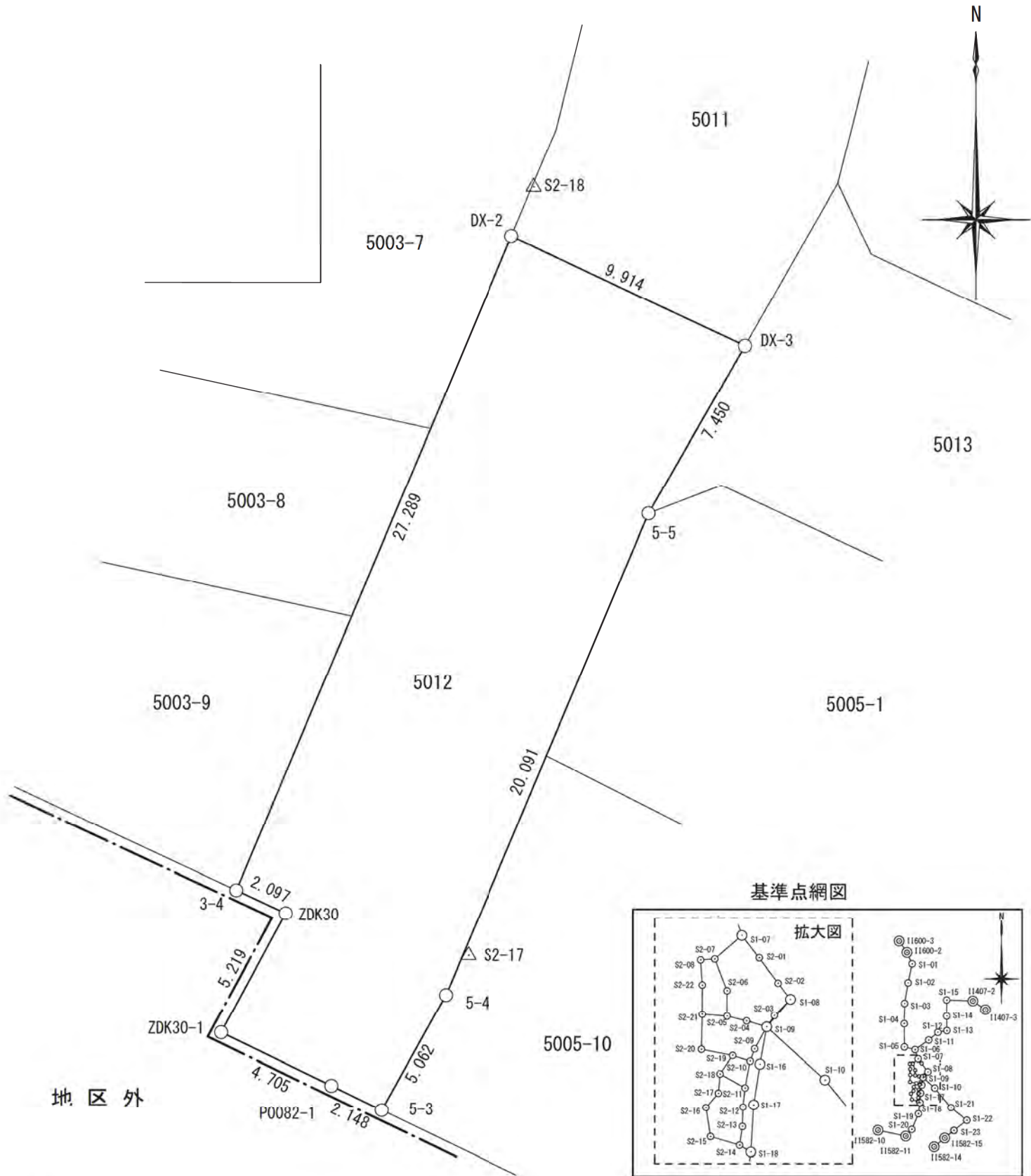

基準点網図

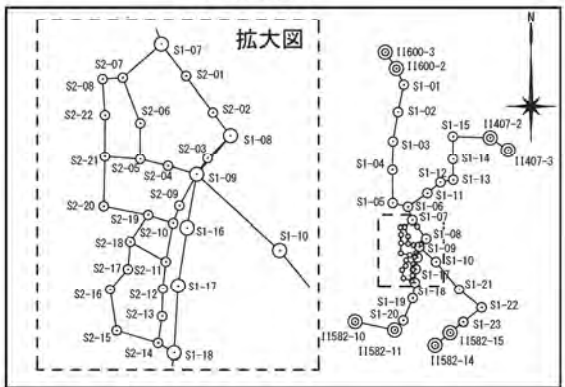

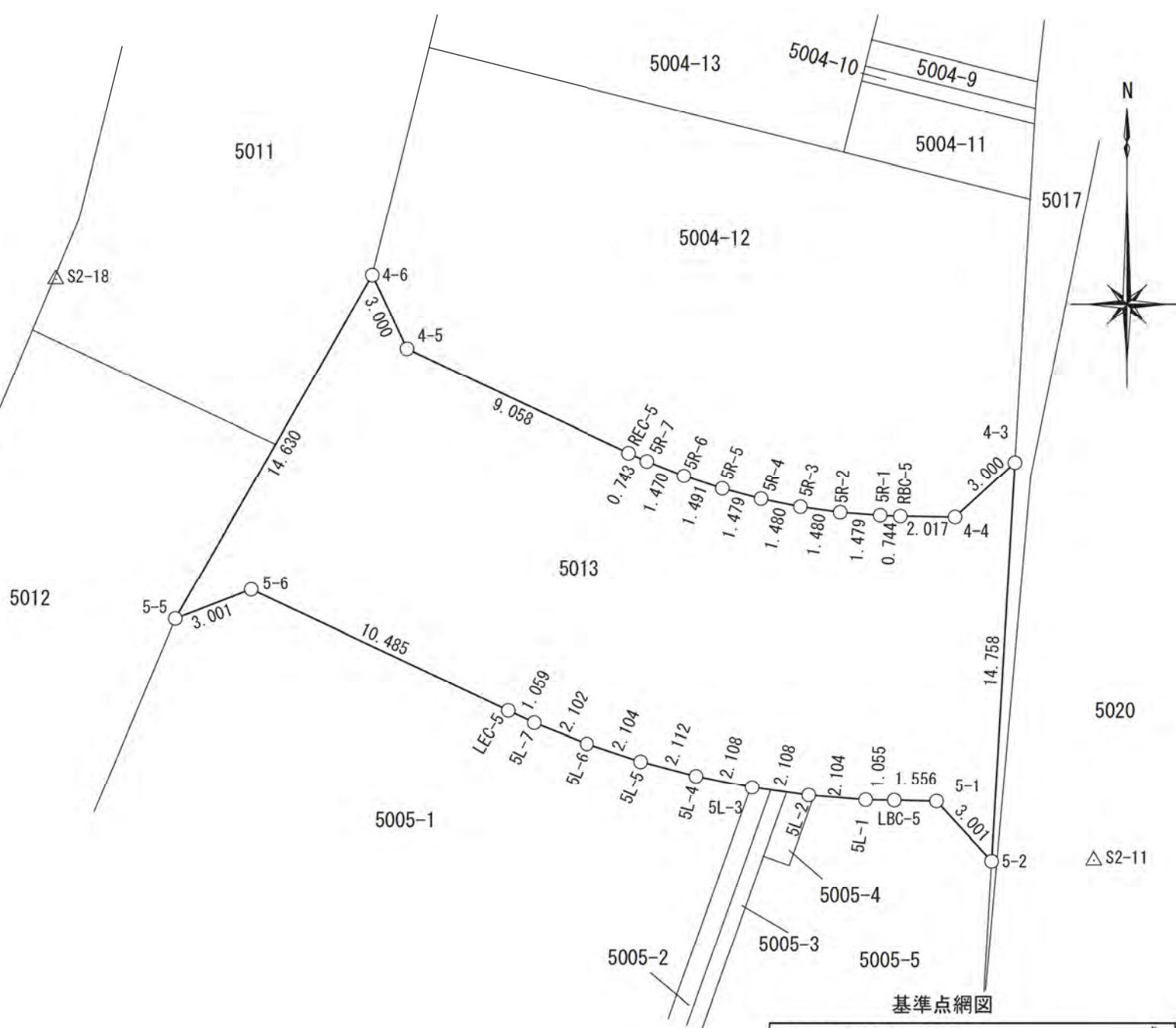

基準点網図

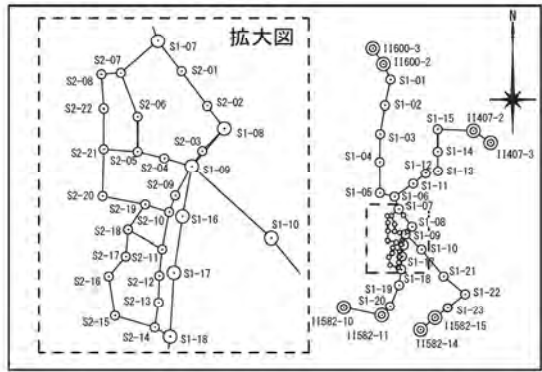

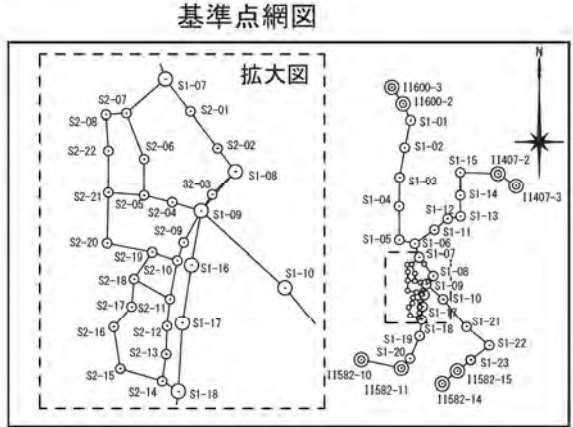
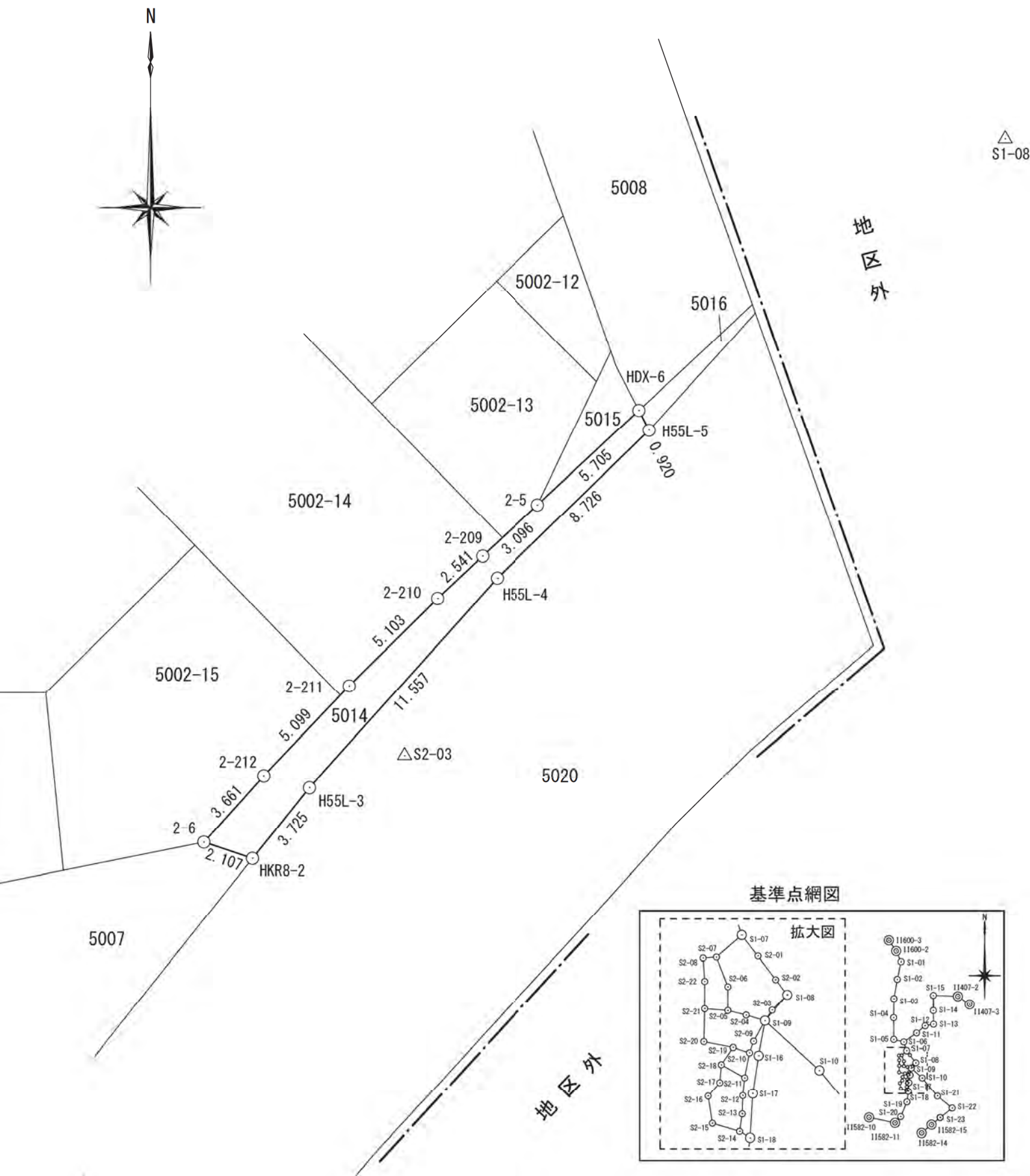

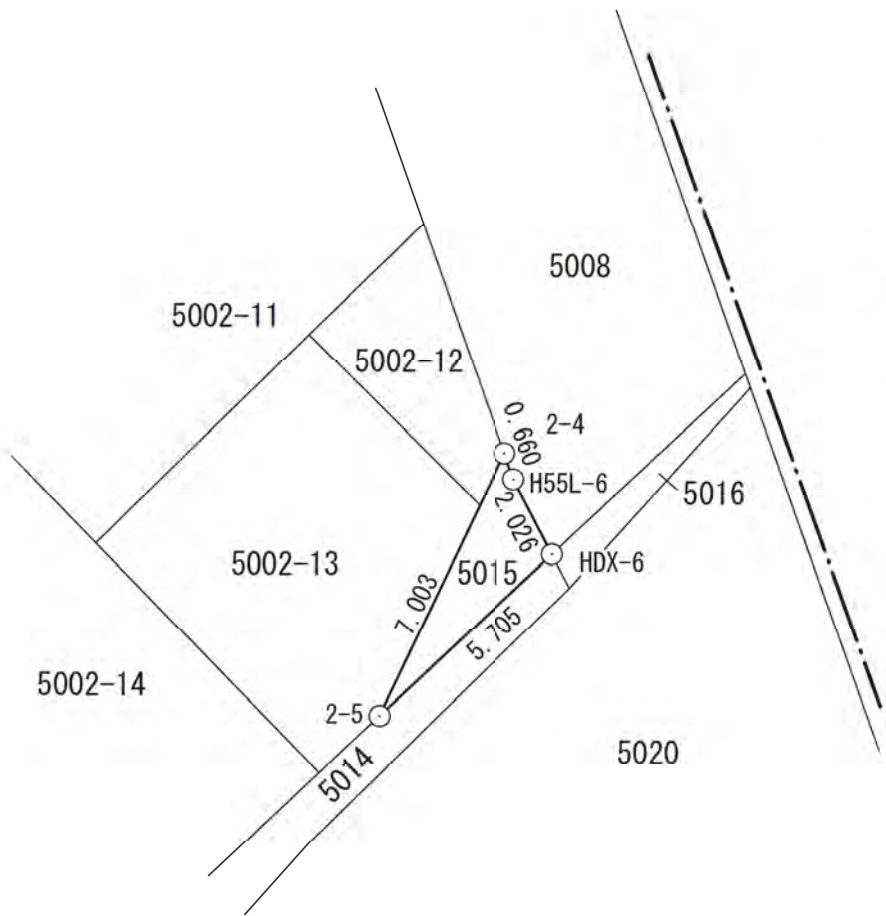

△S1-08

地区外

5002-14

5008

5002-11

5002-12

2-4

H55L-6

5016

5002-13

5015

HDX-6

2-5

5014

5020

基準点網図

△S2-03

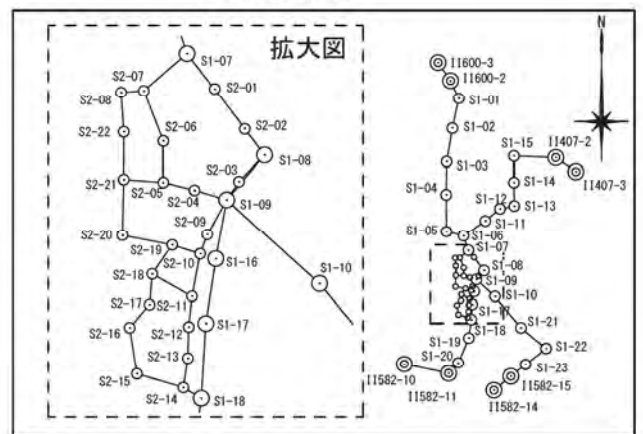

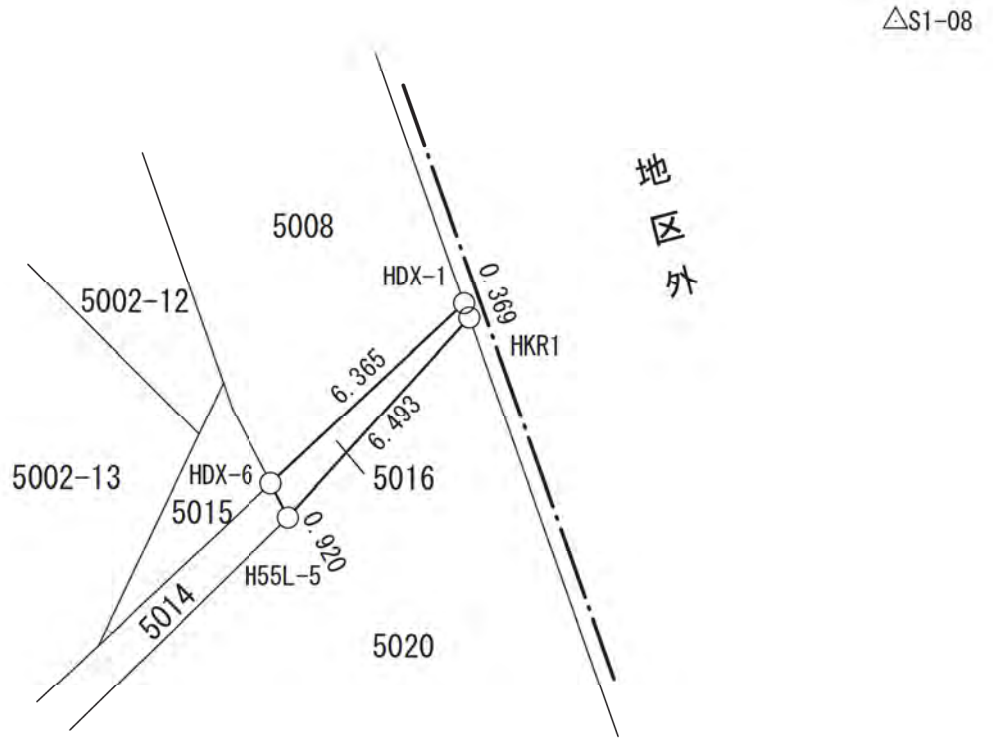

△S2-03

基準点網図

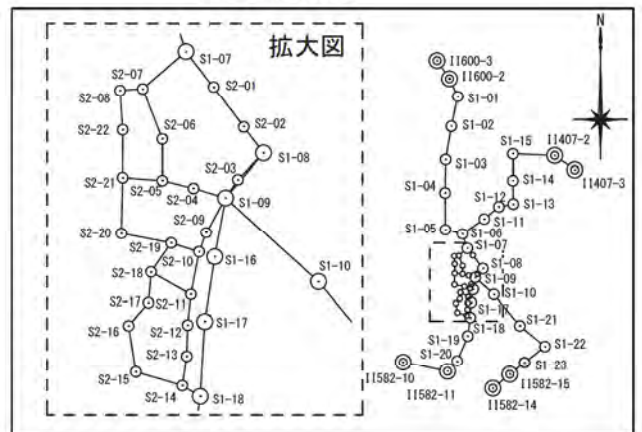

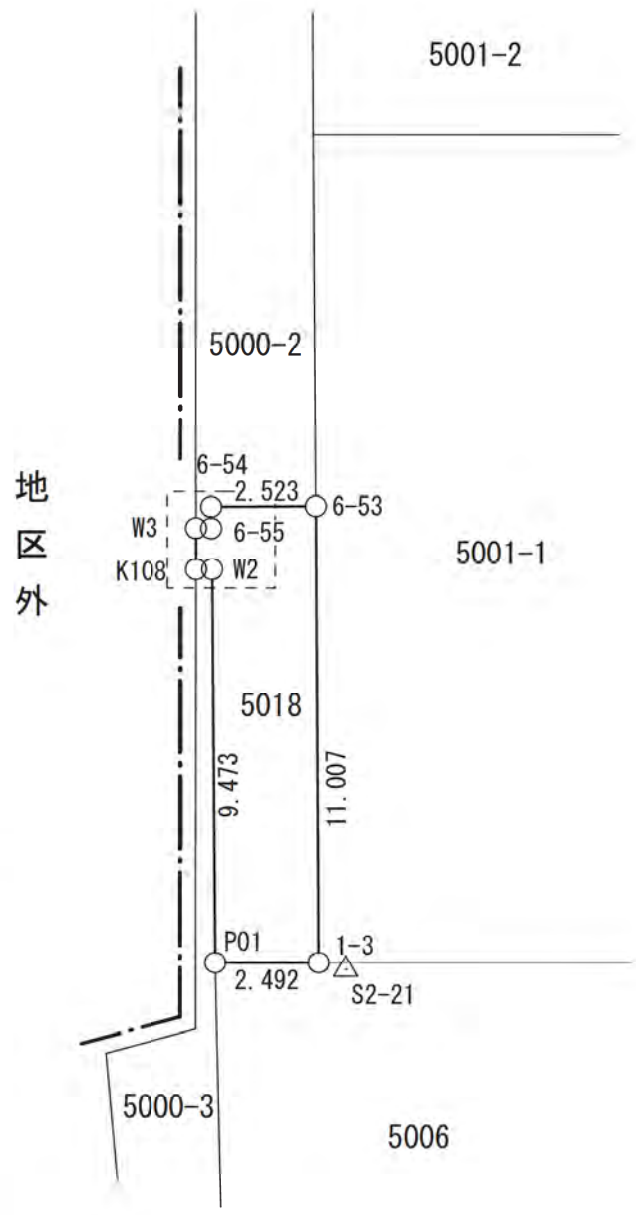

拡大図

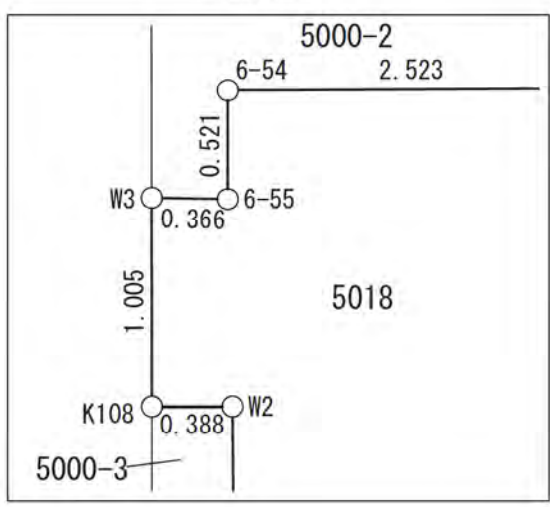

基準点網図

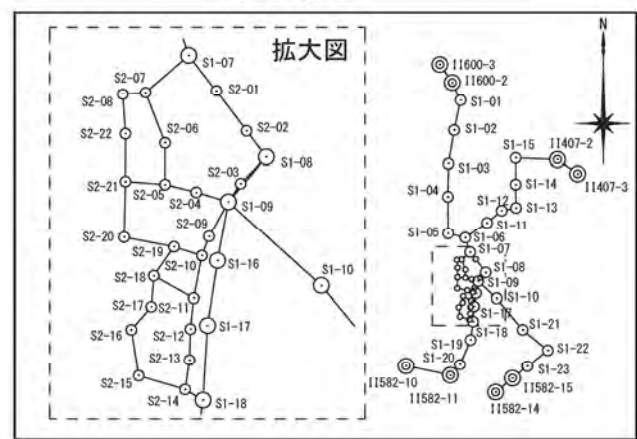

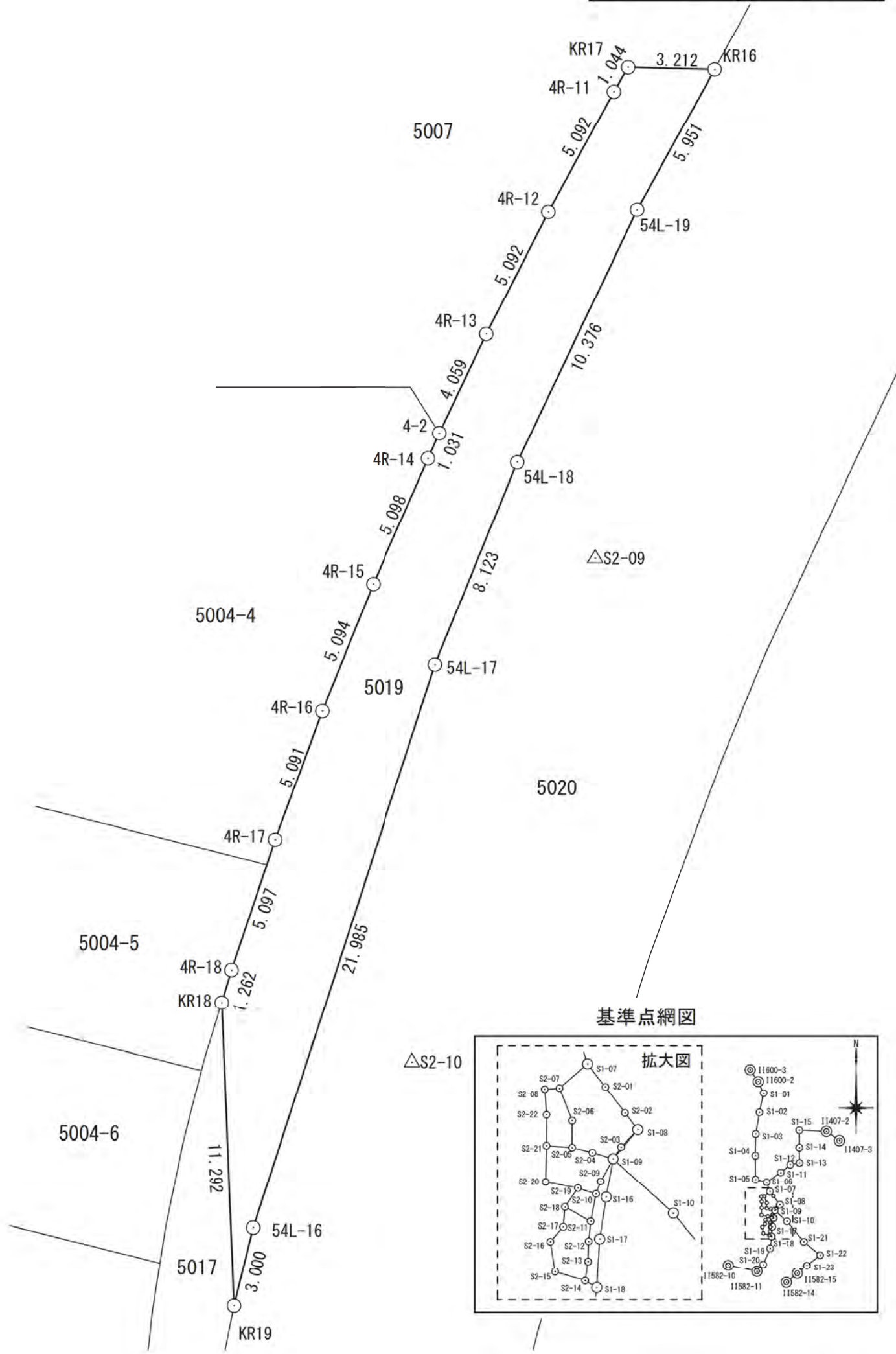

基準点網図

△S2-10

